



# moisture.IQ

## User's Manual





**BAKER  
HUGHES**  
a GE company



# moisture.IQ

*Multi-Channel Moisture and Oxygen Analyzer*

## User's Manual

910-298 Rev. E  
September 2017

[bhge.com](http://bhge.com)

© 2017 Baker Hughes, a GE company – All rights reserved.

Baker Hughes reserves the right to make changes in specifications and features shown herein, or discontinue the product described at any time without notice or obligation. Contact your BHGE representative for the most current information. The Baker Hughes logo is a trade mark of Baker Hughes, a GE company. The GE Monogram is a trademark of the General Electric Company.

[no content intended for this page]

---

Product Registration .....	vii
Services .....	vii
Terms and Conditions .....	vii
Typographical Conventions .....	vii
Safety Issues .....	vii
Auxiliary Equipment .....	viii
Environmental Compliance .....	ix
<b>Chapter 1. Installation</b>	
1.1 Introduction .....	1
1.2 Unpacking the moisture.IQ .....	1
1.3 Installing the moisture.IQ .....	1
1.4 Choosing an Installation Site .....	2
1.4.1 General Site Guidelines .....	2
1.4.2 Low Voltage Directive .....	2
1.5 Moisture Probe Considerations .....	3
1.5.1 Temperature Range .....	3
1.5.2 Moisture Condensation .....	3
1.5.3 Static or Dynamic Use .....	3
1.5.4 Pressure Range .....	4
1.5.5 Long-Term Storage & Operational Stability .....	4
1.5.6 Interference Effects .....	4
1.5.7 Corrosive Materials .....	4
1.6 Sample System Guidelines .....	5
1.6.1 Moisture Sample Systems .....	5
1.6.2 Oxygen Sample Systems .....	6
1.7 Mounting the Hygrometer System .....	7
1.7.1 Mounting the Electronics Unit .....	7
1.7.2 Mounting a Sample System .....	7
1.7.3 Mounting the Oxygen Cell .....	8
1.8 Installing the Probes .....	9
1.8.1 Moisture Probes .....	9
1.8.2 Adapting an Existing TF-Series Probe Cable .....	10
1.8.3 Adapting an Existing M-Series Probe Cable .....	11
1.8.4 Pressure Sensors .....	12
1.8.5 Delta F Oxygen Cell .....	12
1.9 Making Electrical Connections .....	14
1.9.1 Using the Lever to Make Wiring Connections .....	15
1.9.2 Connecting the Input Power .....	16
1.9.3 Connecting Moisture Probes .....	16
1.9.4 Connecting the Delta F Oxygen Cell .....	21

1.10	Establishing a Gas Flow Through the Oxygen Cell .....	26
1.11	Connecting an Auxiliary Device .....	28
1.12	Connecting Analog Outputs .....	29
1.13	Connecting Alarms .....	30
<b>Chapter 2. Operation</b>		
2.1	Powering Up .....	31
2.2	Measurement Display Components.....	31
2.3	The Help Button.....	32
2.4	The Data Element Editor.....	32
2.5	Initial Setup .....	34
2.6	Restarting the System.....	35
2.7	Shutting Down the System .....	36
<b>Chapter 3. Using the Settings Menu</b>		
3.1	Introduction.....	39
3.2	Display Settings .....	40
3.3	System Settings.....	41
3.4	File Manager .....	42
3.5	Screen Alignment (Weatherproof and Explosion-Proof) .....	43
3.6	Screen Configuration (Weatherproof and Explosion-Proof).....	44
3.7	Notifications Setup.....	45
3.8	Fault Alarm Setup .....	46
3.9	Module Setup .....	47
3.10	Service Menu Options .....	48
3.10.1	Software Update .....	48
3.10.2	Restart .....	48
3.10.3	Shut Down .....	48
<b>Chapter 4. Using the Outputs, Alarms and Logger Menus</b>		
4.1	Setting Up the Outputs.....	49
4.1.1	Configuring an Output .....	49
4.1.2	Testing the Selected Output .....	50
4.1.3	Trimming the Selected Output .....	51
4.1.4	Setting the Output Range Error Response.....	52
4.2	Setting Up the Alarms .....	53
4.2.1	Configuring an Alarm .....	53
4.2.2	Testing the Selected Alarm .....	54
4.2.3	Setting the Alarm Range Error Response .....	55
4.3	Setting Up and Running Logs .....	56
<b>Chapter 5. Using the Configuration Menu</b>		
5.1	Configuring the Probes .....	59

---

5.1.1	The Probe Configuration Screen.....	60
5.1.2	Configuring Delta F Oxygen Sensor Probes .....	63
5.1.3	Calibrating Individual Channels .....	64
5.1.4	Setting the Probe Auto-Cal Schedule.....	65
5.2	Calibrating the Probes.....	66
5.2.1	Entering Calibration Data Automatically .....	66
5.2.2	Entering Calibration Data Manually .....	66
5.3	Tagging the Inputs.....	68
5.4	Entering User Information .....	69
5.4.1	Entering User Functions .....	69
5.4.2	Entering User-Defined Tables .....	71
5.4.3	Entering User Constants .....	72
5.4.4	Entering Saturation Constants.....	73
<b>Chapter 6. Setting Up Communications</b>		
6.1	Setting Up moisture.IQ Communications .....	75
6.2	Configuring the Serial Port.....	75
6.3	Configuring the Modbus Connection.....	76
6.4	Connecting to an Ethernet LAN.....	77
6.4.1	Configuring the Ethernet TCP/IP Connection .....	77
6.4.2	Capabilities of the Ethernet Connection.....	78
6.5	Configuring a VNC Connection.....	82
6.6	Configuring the Web Server .....	83
6.7	User Management Operations.....	84
6.8	Setting Up a Remote Connection to a PC.....	85
<b>Chapter 7. Maintenance</b>		
7.1	Delta F Oxygen Cell Electrolyte .....	87
7.1.1	Checking the Electrolyte Level .....	88
7.1.2	Replenishing the Electrolyte .....	88
7.2	Replacing and Recalibrating Moisture Probes .....	89
7.3	Calibrating the Delta F Oxygen Cell .....	89
7.3.1	Displaying Oxygen Content in PPMv and $\mu$ A .....	89
7.3.2	Checking the Oxygen Cell Calibration .....	90
7.4	Delta F Oxygen Cell Background Gas Correction Factors .....	91
7.4.1	Correcting for Different Background Gases.....	91
7.4.2	Entering the Background Gas Correction Factor.....	92
<b>Chapter 8. Troubleshooting</b>		
8.1	Screen Messages.....	93
8.2	Common Problems.....	96

**Chapter 9. Specifications**

9.1 Electronics .....99

9.2 Moisture Measurement..... 100

9.3 Temperature Measurement ..... 100

9.4 Pressure Measurement..... 101

9.5 Oxygen Measurement..... 101

9.6 General Specifications..... 102

9.7 Output Specifications ..... 103

9.8 Input Specifications ..... 104

9.9 Probe Specifications..... 105

**Appendix A. Menu Maps**

A.1 The Settings Menu Map ..... 109

A.2 The Outputs, Alarms and Logger Menu Map..... 110

A.3 The Configuration > Probe & User Menu Maps ..... 111

A.4 The Configuration > Comms Menu Map..... 112

**Appendix B. Wiring Diagrams**

B.1 Terminal Blocks ..... 113

B.2 Rear View Channel Configurations..... 114

B.3 Power Wiring..... 115

B.4 RS-485 Wiring..... 116

**Appendix C. Updating the moisture.IQ Firmware**

C.1 Updating the Chassis Firmware..... 117

C.2 Updating the moisture.IQ Module Firmware ..... 121

**Appendix D. Modbus Register Map**



---

## Product Registration

Thank you for purchasing your *moisture.IQ* from Baker Hughes, a GE Company. Please register your product at [www.gemeasurement.com/productregistration](http://www.gemeasurement.com/productregistration) for product support such as the latest software/firmware upgrades, product information and special promotions.

## Services

BHGE provides customers with an experienced staff of customer support personnel ready to respond to technical inquiries, as well as other remote and on-site support needs. To complement our broad portfolio of industry-leading solutions, we offer several types of flexible and scalable support services including: Training, Product Repairs, Extended Warranties, Service Agreements and more. Please visit [www.gemeasurement.com/services](http://www.gemeasurement.com/services) for more details.

## Terms and Conditions

Sales *Terms and Conditions* for your recent purchase of a BHGE product, including the applicable product Warranty, can be found on our website at the following link:

[www.gemeasurement.com/sales-terms-and-conditions](http://www.gemeasurement.com/sales-terms-and-conditions)

## Typographical Conventions

**Note:** *These paragraphs provide information that provides a deeper understanding of the situation, but is not essential to the proper completion of the instructions.*

**IMPORTANT:** *These paragraphs provide information that emphasizes instructions that are essential to proper setup of the equipment. Failure to follow these instructions carefully may cause unreliable performance.*



**CAUTION!** This symbol indicates a risk of potential minor personal injury and/or severe damage to the equipment, unless these instructions are followed carefully.



**WARNING!** This symbol indicates a risk of potential serious personal injury or death, unless these instructions are followed carefully.

## Safety Issues



**WARNING!** It is the responsibility of the user to make sure all local, county, state and national codes, regulations, rules and laws related to safety and safe operating conditions are met for each installation.



**Attention European Customers!** To meet CE Marking requirements for all units intended for use in the EU, all electrical cables must be installed as described in this manual.

## Auxiliary Equipment

### Local Safety Standards

The user must make sure that he operates all auxiliary equipment in accordance with local codes, standards, regulations, or laws applicable to safety.

### Working Area



**WARNING!** Auxiliary equipment may have both manual and automatic modes of operation. As equipment can move suddenly and without warning, do not enter the work cell of this equipment during automatic operation, and do not enter the work envelope of this equipment during manual operation. If you do, serious injury can result.



**WARNING!** Make sure that power to the auxiliary equipment is turned OFF and locked out before you perform maintenance procedures on this equipment.

### Qualification of Personnel

Make sure that all personnel have manufacturer-approved training applicable to the auxiliary equipment.

### Personal Safety Equipment

Make sure that operators and maintenance personnel have all safety equipment applicable to the auxiliary equipment. Examples include safety glasses, protective headgear, safety shoes, etc.

### Unauthorized Operation

Make sure that unauthorized personnel cannot gain access to the operation of the equipment.

---

## Environmental Compliance

### RoHS

The moisture.IQ fully complies with RoHS regulations (Directive 2011/65/EU).

### Waste Electrical and Electronic Equipment (WEEE) Directive

BHGE is an active participant in Europe's *Waste Electrical and Electronic Equipment (WEEE)* take-back initiative (Directive 2012/19/EU).



The equipment that you bought has required the extraction and use of natural resources for its production. It may contain hazardous substances that could impact health and the environment.

In order to avoid the dissemination of those substances in our environment and to diminish the pressure on the natural resources, we encourage you to use the appropriate take-back systems. Those systems will reuse or recycle most of the materials of your end life equipment in a sound way.

The crossed-out wheeled bin symbol invites you to use those systems.

If you need more information on the collection, reuse and recycling systems, please contact your local or regional waste administration.

Please visit <http://www.gemeasurement.com/environmental-health-safety-ehs> for take-back instructions and more information about this initiative.

[no content intended for this page]

# Chapter 1. Installation

## 1.1 Introduction

Users typically install the moisture.IQ as part of a complex process system, which includes components such as filters, pumps, and pressure regulators. In such an environment, probes and other parts of the system may be subjected to environmental hazards, such as high temperature, pressure extremes, corrosive elements and mechanical vibrations.

This section contains information and instructions for installing the moisture.IQ into a process system, while taking into account all of the above factors. The following section describes how to set up and connect the moisture.IQ.

If you have questions about the installation procedures, contact our technical support department. See the rear cover of this manual for contact information.

## 1.2 Unpacking the moisture.IQ

Before beginning the installation, unpack the unit and make sure all the parts and documentation listed on the packing slip are included. Be sure to inspect each piece of equipment, including the sample system, for evidence of mishandling. If anything has been damaged or is missing, report this to the carrier and to BHGE immediately.

## 1.3 Installing the moisture.IQ

To install the moisture.IQ, refer to the drawing for your specific configuration (benchtop, rack mount, panel mount, weatherproof or explosion-proof) in the Certification and Safety Statements at the end of this manual.



**WARNING!** To ensure the safe operation of this unit, you must install and operate the moisture.IQ as described in this user's manual. In addition, be sure to follow all applicable safety codes and regulations for installing electrical equipment in your area.



**WARNING!** For Zone 2 Stainless Steel: Do not rub front face with a dry cloth within the hazardous area as a spark may occur.

## 1.4 Choosing an Installation Site

You should have discussed environmental and installation factors with a BHGE applications engineer or field sales person by the time you receive the meter. The equipment provided should be suited to your application and installation site.

The moisture.IQ is available in rack-mount, bench top, or panel-mount versions that are suitable for most indoor installations. BHGE also provides weatherproof and explosion-proof housings for outdoor and hazardous area locations. See the drawings in *the Certification and Safety Statements* at the end of this manual for details of each enclosure.

Before installing the unit, read the guidelines below to verify that you have selected the best installation site.

### 1.4.1 General Site Guidelines

- Choose an installation site for the probes and sample systems that is as close to the process line as possible. Avoid long lengths of connecting tubing. If long distances are unavoidable, a fast sampling by-pass loop is recommended. Do not install any other components, such as filters, upstream from the probes or sample system unless instructed to do so by BHGE.
- Observe all normal safety precautions. Use the probes within their maximum pressure and temperature ratings.
- Although the moisture.IQ may not need to be accessed during normal operation, install the electronics unit at a convenient location for programming, testing and servicing. A control room or instrument shed are typical locations.
- Locate the electronics unit away from high temperatures, strong electrical transients, mechanical vibrations, corrosive atmospheres, and any other conditions that could damage or interfere with the meter operation. See *Chapter 9. "Specifications" on page 99* for environmental limits.
- Protect the probe cables from excessive physical strain (e.g., bending, pulling, twisting, etc.).
- Observe the proper cable restrictions for the probes. You can locate *Moisture Image Series* probes up to 915 m (3000 ft) from the electronics unit with unshielded twisted-pair cable. *M-Series* probes can be located up to 600 m (2000 ft) from the unit with the use of specially shielded cable.

### 1.4.2 Low Voltage Directive

If the power mains switch on the unit remains accessible to the user after installation a disconnect device is not required. However, if installation blocks access to the power mains switch, compliance with the EU Low Voltage Directive (IEC 61010) requires an external power disconnect device such as a switch or circuit breaker. The disconnect device must be marked as such, clearly visible, directly accessible, and located within 1.8 m (6 ft) of the unit.

## 1.5 Moisture Probe Considerations

The *M-Series* and *Moisture Image Series* probes consist of an aluminum oxide sensor mounted on a connector head. Standard probe mounts include a protective stainless steel shield.

The probe sensor materials and housing maximize durability and insure a minimum of water absorbing surfaces in the vicinity of the aluminum oxide surface. A sintered stainless steel shield is used to protect the sensor from high flow rates and particulate matter. The end cap should not be removed except upon advice from BHGE.

The sensor has been designed to withstand normal shock and vibration. You should make sure that the active sensor surface is never touched or allowed to come into direct contact with foreign objects, since this may adversely affect performance.

Observing these few simple precautions will result in a long and useful probe life. BHGE recommends that probe calibration be checked routinely, at 12-month intervals, or as recommended by our applications engineers for your particular application.

The probe will measure the water vapor pressure in its immediate vicinity. Therefore, readings will be influenced by its proximity to the system walls, materials of construction, and other environmental factors. The sensor can be operated under vacuum or pressure and under flowing or static conditions.

See the following sections for the recommended environmental precautions.

### 1.5.1 Temperature Range

See “*Probe Specifications*” on page 105, for details.

### 1.5.2 Moisture Condensation

Be sure the temperature is at least 10°C higher than the dew/frost point temperature. If this condition is not maintained, moisture condensation could occur on the sensor or in the sample system, which will cause reading errors. If this happens, dry out the probe following the procedures outlined in BHGE document #916-064, *Basic Hygrometry Principles*.

### 1.5.3 Static or Dynamic Use

The sensor performs equally well in still air or where considerable flow occurs. Its small size makes it ideal for measuring moisture conditions within completely sealed containers or dry boxes. It will also perform well under gas flow conditions as high as 10,000 cm/sec and liquid flow conditions up to 10 cm/sec. Refer to BHGE document #916-064, *Basic Hygrometry Principles*, for maximum flow rates in gases and liquids.

### **1.5.4 Pressure Range**

The moisture probe always senses the correct water vapor pressure regardless of the total ambient pressure. The moisture sensor measures water vapor under vacuum or high pressure conditions from as little as a few microns of Hg to as high as 5000 psi total pressure.

### **1.5.5 Long-Term Storage & Operational Stability**

Sensors are not affected by continuous abrupt humidity changes or damaged by exposure to saturation conditions even when stored. However, you should store probes in their original shipping containers in a clean, dry location. If the probe is saturated during storage, refer to “*Moisture Condensation*” on page 3 before installing the probe. For best performance, do not store probes longer than one to two years from their calibration date.

### **1.5.6 Interference Effects**

The sensor is completely unaffected by the presence of a wide variety of gases or organic liquids. Large concentrations of hydrocarbon gases, Freon™, ozone, carbon dioxide, carbon monoxide, and hydrogen have no effect on sensor water vapor indications. The sensor will operate properly in a multitude of gaseous or non-conductive liquid environments.

### **1.5.7 Corrosive Materials**

Avoid all materials that are corrosive or otherwise damaging to aluminum or aluminum oxide. These include strongly acidic or basic materials and primary amines.



## 1.6 Sample System Guidelines

A sample system is required for oxygen measurement and, although not mandatory, is highly recommended for moisture measurement. The purpose of a sample system is to condition or control a sample stream to within the specifications of a probe. The application requirements determine the design of the sample system. BHGE applications engineers will make recommendations based on the following general guidelines.

### 1.6.1 Moisture Sample Systems

Typically, sample systems should be kept very simple. They should contain as few components as possible and all or most of those components should be located downstream of the measurement probe. *Figure 1* below shows an example of a basic sample system consisting of an explosion-proof housing with a sample cell, a filter, a flow meter, a vent valve, an inlet shut-off valve and an outlet shut-off valve.

The sample system components should not be made of any material that will affect measurements. A sample system may include a filter to remove particulates from the sample stream or a pressure regulator to reduce or control the pressure of the stream. However, most common filters and pressure regulators are not suitable for sample systems because they have wetted parts that may absorb or release components (such as moisture) into the sample stream. They may also allow ambient contamination to enter the sample stream. In general, you should use stainless steel construction for all wetted parts. Contact BHGE for further instructions.

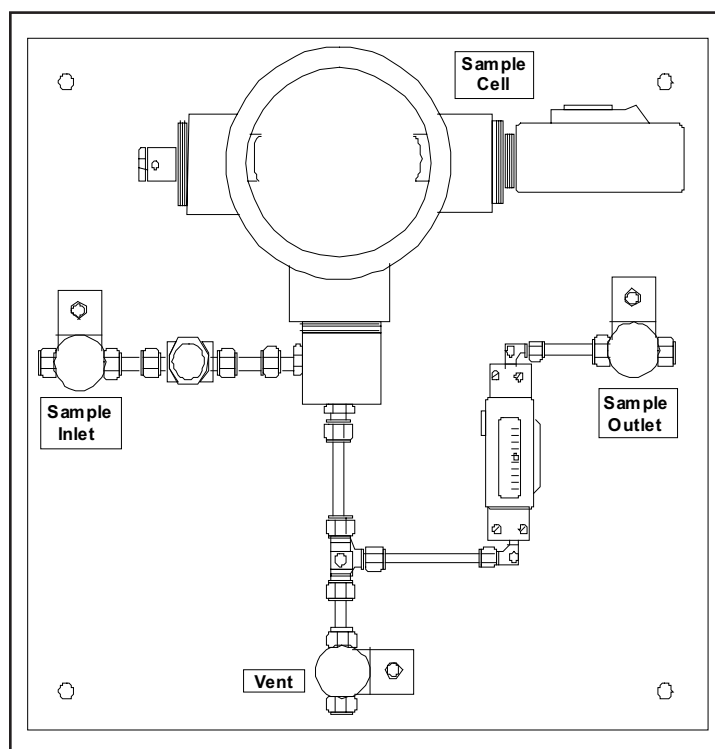

**Figure 1: A Typical Moisture Sample System**

**Note:** *The actual sample system design is dependent on the application requirements.*

## 1.6.2 Oxygen Sample Systems

Oxygen sample systems are required and can be ordered from BHGE for bench or wall mounting. You can also build your own sample system by using the following guidelines.

**IMPORTANT:** *The BHGE warranty will be voided if the sample system does not have a relief valve.*

The basic sample system requirements are as follows (see Figure 2 below):

- The oxygen cell requires a sample gas flow of 0.5 to 1 LPM (1 to 2 SCFH).
- The gas pressure in the sample cell must be between 0.0 and 1.0 psig. The pressure must not exceed 1.0 psig.
- A 10 psig pressure relief valve installed upstream of the oxygen cell is required to prevent over-pressure.
- A flow meter is required to measure the flow.
- A pressure gauge is required to measure the pressure.
- A flow regulating or needle valve is required and should be located upstream of the sample cell.
- A pressure regulator is required for sample gas supplies of 50 psig or greater.

If a sample pump is required to draw a sample to the oxygen cell, the pump should be installed downstream from the oxygen cell. You must also install a vacuum relief valve set at 1.0 psig between the oxygen cell and the pump.

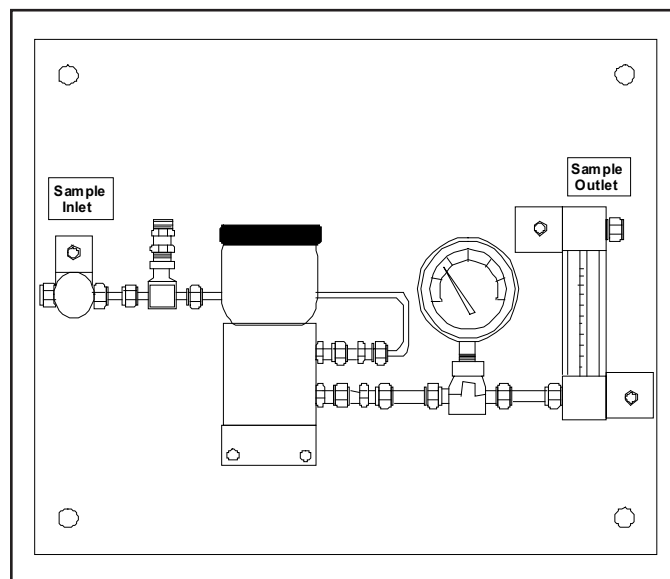

**Figure 2: A Typical Oxygen Cell Sample System**

**Note:** *The actual sample system design is dependent on the application requirements.*

## 1.7 Mounting the Hygrometer System

Mounting the hygrometer system consists of mounting the electronics unit, the probes, and the sample systems.

### 1.7.1 Mounting the Electronics Unit

Use the outline and dimension drawings in *the Certification and Safety Statements* at the end of this manual to mount the moisture.IQ. These drawings provide clearance and other mounting dimensions needed to prepare the site for mounting.



**WARNING!** If the power mains switch on the unit remains accessible to the user after installation, a disconnect device is not required. However, if the installation blocks access to the power mains switch, compliance with the EU's Low Voltage Directive (IEC 61010) requires an external power disconnect device such as a switch or circuit breaker. The disconnect device must be marked as such, clearly visible, directly accessible, and located within 1.8 m (6 ft) of the unit.

Be sure to follow the guidelines outlined in “*Choosing an Installation Site*” on page 2 before mounting the enclosure.

**Note:** *If the installation location does not provide enough room for connections to be made easily after installation, you may want to make connections to the MIS or M-Series probes, Delta F Oxygen Cell, Outputs and Alarms before mounting the instrument.*

### 1.7.2 Mounting a Sample System

BHGE sample systems are normally fastened to a metal plate that has four mounting holes. BHGE can also provide the sample system in an enclosure, if requested. In either case, fasten the sample system plate or enclosure with bolts in the mounting holes at each of the four corners. If you ordered sample system outline and dimension drawings, they will be included in your shipment.

Connect the sample system inlet to the process and the outlet to the return, using the appropriate fittings or an appropriate NPT adapter.



**CAUTION!** Do not start a flow through the sample system until all probes and transmitters are properly installed.

### 1.7.3 Mounting the Oxygen Cell

If your oxygen cell is not mounted in a sample system, refer to the *Figure 3* below for mounting details.

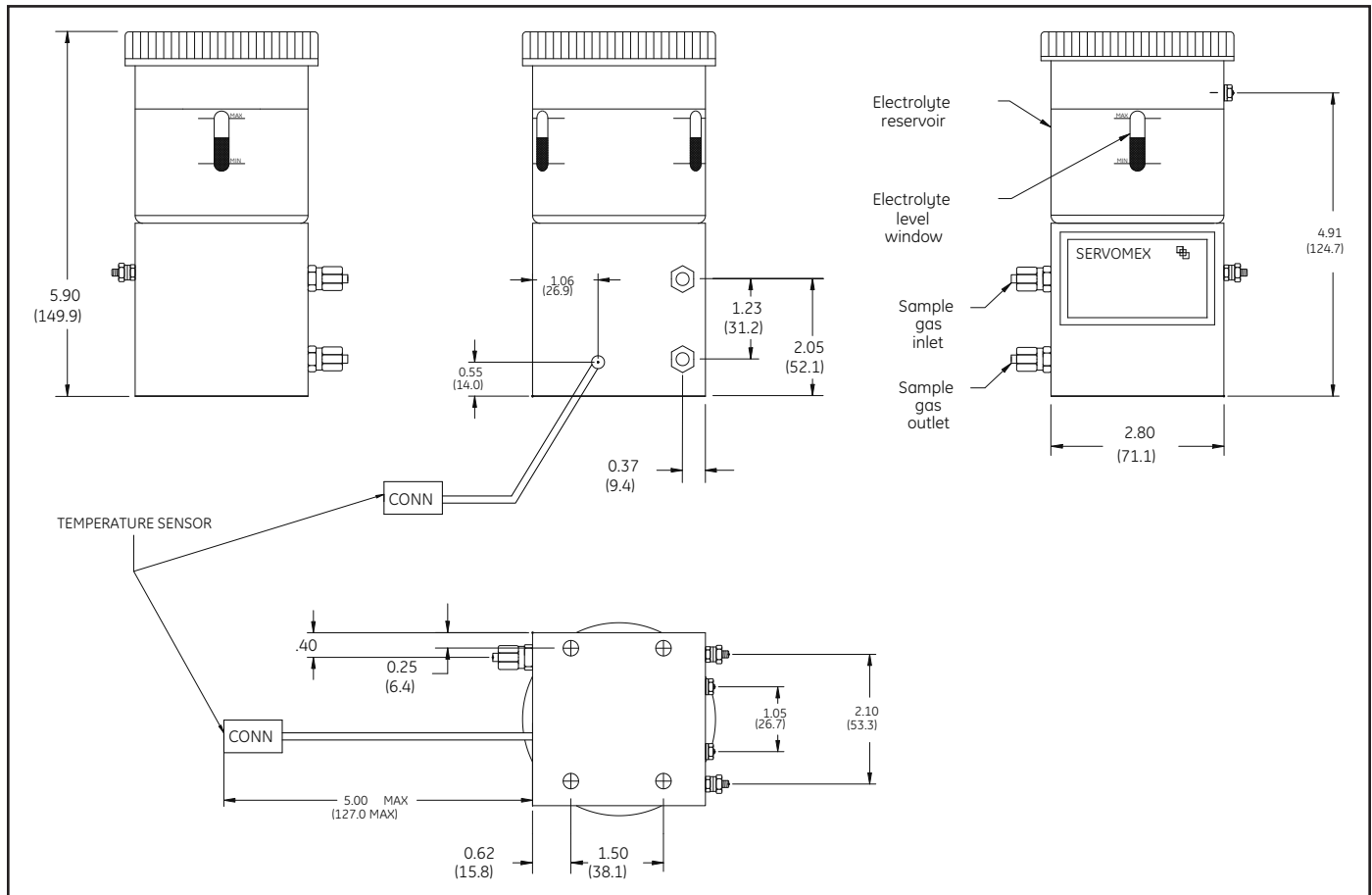

**Figure 3: Oxygen Cell Dimensions**

## 1.8 Installing the Probes

After you mount the sample system, you must insert the moisture probes into the sample cells. In addition, you must check, prepare, and connect any installed oxygen cells to the gas line.

### 1.8.1 Moisture Probes

BHGE *Moisture Image Series* (MIS) and *M-Series* moisture probes have 3/4 inch-16 straight threads, with an O-ring seal, to secure the probes into the sample system or directly into the process line. Other fittings are available for special applications.



**CAUTION!** If mounting the moisture probes directly into the process line, you must consult BHGE for proper installation instructions and precautions.

Moisture probes are usually installed into a sample system. The sample system protects the probes from coming into contact with damaging elements in the process. Moisture probes are installed into a cylindrical shaped container, called the *sample cell*, which is included as part of your sample system. The sample cell is identified by a label on the sample system plate.

To install a moisture probe that has a 3/4 inch-16 straight thread, insert it into the sample cell so it is perpendicular to the sample inlet. Screw the probe into cell, making sure not to cross thread it, and tighten it securely. *Figure 4* below shows a typical moisture probe installation, with the probe mounted in a BHGE sample cell. Install any moisture probes with different fittings in the appropriate manner.

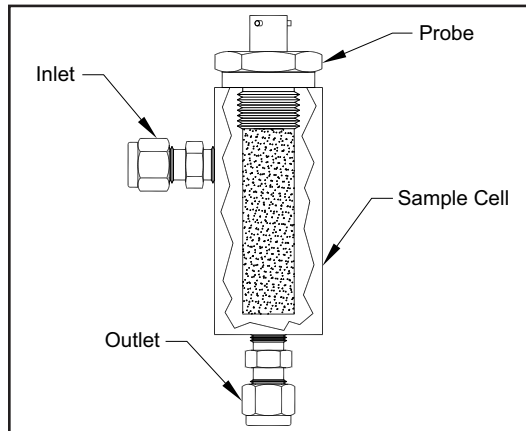

**Figure 4: Typical Moisture Probe in Sample Cell**

**Note:** *Standard moisture probes have a sintered stainless steel shield that protects the aluminum oxide sensor. Be sure to leave the shield in place for maximum protection.*

It is important to eliminate all gas or liquid leaks for safety reasons and to ensure that measurements are not affected by ambient contamination. For gas applications, you should check for leaks using a soap bubble solution.

**IMPORTANT:** *Refer to the Calibration Data Sheets to connect the probes to their corresponding channels. If a probe is connected to the wrong channel, the meter will display incorrect data.*

## 1.8.2 Adapting an Existing TF-Series Probe Cable

If an existing moisture measurement system uses a **TF-Series** moisture probe, the cable for that probe may be adapted for use with an **MISP2** probe. To retrofit the existing system, refer to *Figure 5* below and complete the following steps:

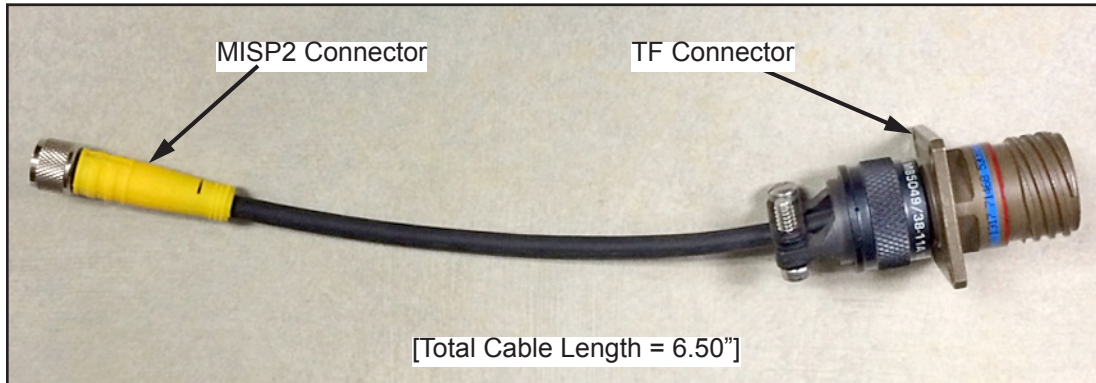
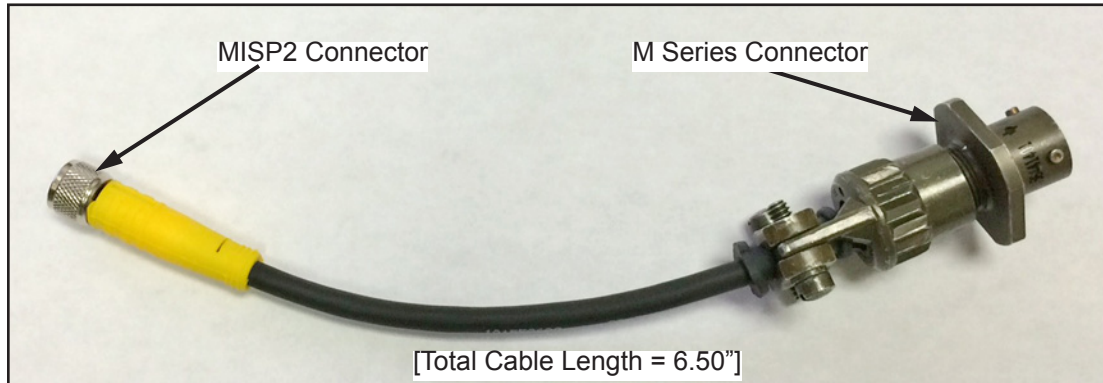

**Figure 5: TF-MISP2 Converter Cable**

1. Locate the existing **TF-Series** probe and disconnect the cable from the probe.
2. Replace the **TF-Series** probe with an **MISP2** probe.
3. Using BHGE *adapter cable 704-1362-00*, shown in *Figure 5* above, connect one end of the cable to the **MISP2** probe and connect the other end to the existing **TF-Series** cable connector.
4. At the moisture analyzer end of the **TF-Series** cable, locate the same **TF-Series** cable and disconnect all flying leads from the pluggable connector.
5. Locate the **BLACK** and **WHITE** wires of the **TF-Series** cable and connect them to the moisture.IQ at the **MISP2** probe gray pluggable connector. See “*Moisture Image Series Probes (MISP and MISP2)*” on page 19 for help.
6. Trim all other flying leads from the **TF-Series** cable flush with the jacket.
7. Plug the newly-wired **MISP2** probe pluggable connector into the moisture.IQ.

### 1.8.3 Adapting an Existing M-Series Probe Cable

If an existing moisture measurement system uses a M-Series moisture probe, the cable for that probe may be adapted for use with an **MISP2** probe. To retrofit the existing system, refer to *Figure 6* below and complete the following steps:



**Figure 6: M-MISP2 Converter Cable**

1. Locate the existing **M-Series** probe and disconnect the cable from the probe.
2. Replace the **M-Series** probe with an **MISP2** probe.
3. Using BHGE *adapter cable 704-1649-00*, connect one end of the cable to the **MISP2** probe and connect the other end to the existing **M-Series** cable connector.
4. At the moisture analyzer end of the **M-Series** cable, locate the same **M-Series** cable and disconnect all flying leads from the pluggable connector.
5. Locate the **GREEN** and **RED** wires of the **M-Series** cable and connect them to the **BLACK** and **WHITE** wires at the **MISP2** probe gray pluggable connector. (The **GREEN** wire is connected to the **MISP** connector "**BLK**" label and **RED** wire is connected to the **MISP** connector "**WHT**" label.) See "*Moisture Image Series Probes (MISP and MISP2)*" on page 19 for help.
6. Trim all other flying leads from the **M-Series** cable flush with the jacket.
7. Plug the newly-wired **MISP2** probe pluggable connector into the moisture.IQ.

### 1.8.4 Pressure Sensors

If a pressure input is required and if an optional pressure signal is not available from a Moisture Image Series probe, you can connect a separate pressure transmitter to an auxiliary input.

The moisture.IQ accepts any 0 to 20-mA, 4 to 20-mA, or 0 to 2-V pressure transmitters.

Always mount the pressure transmitter directly downstream from the moisture probe to ensure that the pressure is measured at the same point as the moisture measurement.

### 1.8.5 Delta F Oxygen Cell

Although the moisture.IQ accepts other oxygen devices as auxiliary inputs, it is designed to accept oxygen inputs directly from the *Delta F Oxygen Cell*. There are three steps for installing the Delta F Oxygen Cell:

1. Prepare the oxygen cell for operation
2. Calibrate the oxygen cell.
3. Connect the oxygen cell to the gas line.

The Delta F Oxygen Cell is available with various types of mounting enclosures. However, the cell itself will always look like the one shown in *Figure 7* below.

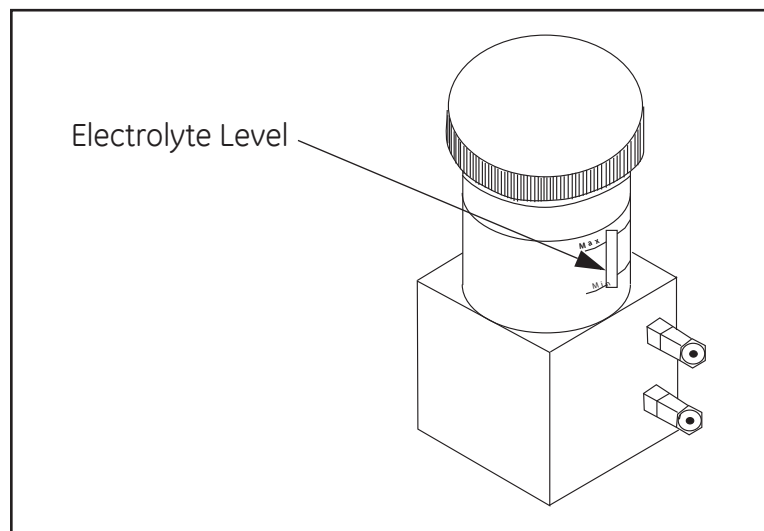

**Figure 7: Delta F Oxygen Cell Electrolyte Level**



### 1.8.5.1 Preparing the Oxygen Cell

To prepare the oxygen cell for operation, you must fill it with the electrolyte that was supplied in a plastic bottle.



**WARNING!** The electrolyte contains potassium hydroxide that is harmful if it comes in contact with eyes or skin. Consult your company safety personnel for proper procedures for handling the electrolyte.

1. Unscrew the top cover on the oxygen cell reservoir.
2. Slowly add the entire contents of the electrolyte bottle, approximately three ounces (90 ml), making sure not to spill any on the outside of the cell. Be especially careful that the electrolyte does not come in contact with any of the cell electrical connections.
3. Using the min/max window on the oxygen cell, check the electrolyte level. The electrolyte should cover about 60% of the window (see *Figure 7 on page 12*). The cell is now ready to be connected to the gas line.
4. Replace the top cover on the oxygen cell.

**Note:** After you add the electrolyte, **DO NOT** add additional electrolyte to the reservoir. If the level falls below the minimum level, refer to “Delta F Oxygen Cell Electrolyte” on page 87 to replenish the cell.

5. Calibrate the oxygen cell as described in “Calibrating the Delta F Oxygen Cell” on page 89. After you calibrate the oxygen cell, connect it to the gas line as described in the following section.

### 1.8.5.2 Connecting the Oxygen Sample System to the Gas Line

To connect the oxygen sample system to the process line, attach a 1/8 inch O. D. (outside diameter) tube to the 1/8 inch sample gas inlet fitting, using a Swagelok® or equivalent mating connector. Avoid using plastic or rubber for any tubings or fittings which are included in the inlet gas lines.



**WARNING!** Do not connect the oxygen cell outlet to flow restricting devices, pressure lines, or vacuum lines. Pressure differentials across the oxygen cell sensor in excess of 1 psig could be harmful or damage the cell.

If the gas being monitored does not create a safety hazard, vent it to atmosphere at the sample system outlet. If venting the gas to atmosphere causes a safety hazard, vent the gas to a safe location. Make sure the venting system does not create a back pressure on the oxygen cell.

**Note:** The vented sample will not be corrosive if you install and operate the cell properly.

## 1.9 Making Electrical Connections



**WARNING!** To ensure the safe operation of this unit, you must install and operate the moisture.IQ as described in this user's manual. In addition, be sure to follow all applicable safety codes and regulations for installing electrical equipment in your area.



**WARNING!** Turn off the moisture.IQ before making any electrical connections.



**WARNING!** The stainless steel Weatherproof enclosure must be properly grounded.

To open a *Weatherproof* moisture.IQ unit, use a large, flat-bladed screwdriver to turn the latch on the enclosure cover.

To open an *Explosion-Proof* moisture.IQ unit, remove all 24 bolts from around the periphery of the enclosure cover. Do not open an Explosion-Proof moisture.IQ unit that is energized.

To facilitate wiring, Weatherproof and Explosion-Proof moisture.IQ units are equipped with a hinging Chassis that can be swung out and rested on a rod support. During normal use, the Chassis is fixed in place by a latch mechanism located at the center of the mounting panel.

To release the Chassis from its locked position, the latch pin at the center of the mounting panel is pushed upwards (in the direction indicated by the surrounding label). To lock the Chassis in place, the Chassis is pushed down towards the mounting panel until the latch engages. In order to safely move the Chassis after cables are installed, service loops for the Weatherproof units shall be at least 20 inches. Service loops for the Explosion-Proof units shall be at least 18 inches

Make all connections to the back of the meter (see *Figure 8* on the next page):

- The probe connections in the left two sections are for **Module A - Channels 1, 2, 3**.
- The probe connections in the right two sections are for **Module B - Channels 4, 5, 6**.
- For each Module, the left group of probe connections (**MIS, M-SERIES, O2T** and **OXYGEN**) are rated for hazardous area use, while the right group of probe connections (**AUX IN/OUT** and **ALARMS**) are rated for non-hazardous area use.
- The connections along the bottom of the panel are for power input and remote devices.

## 1.9 Making Electrical Connections (cont.)

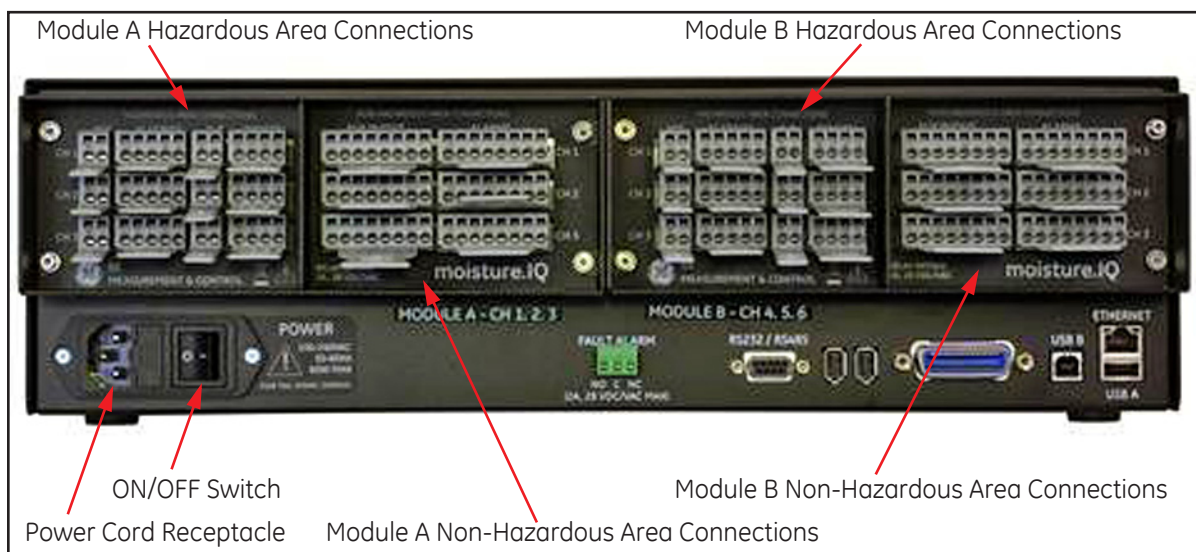
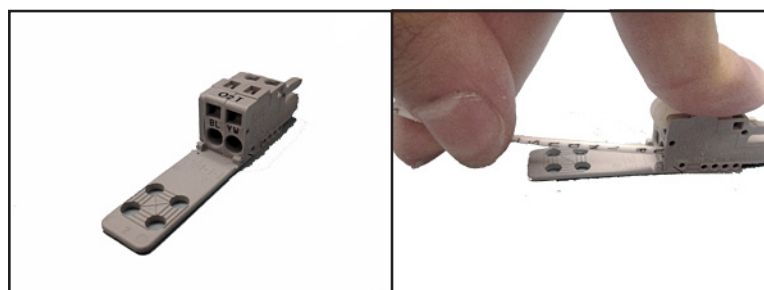

**Figure 8: Rear Panel Connections**

### 1.9.1 Using the Lever to Make Wiring Connections

Use the included levers to assist with wiring the cables to the terminal blocks, as shown in *Figure 9* below:

1. Press and hold the lever against the terminal block.
2. Insert the wire into the terminal block.
3. Release the lever to secure the connection.



**Figure 9: Using the Press Lock Lever**

**IMPORTANT:** To maintain good contact at each terminal block and to avoid damaging the pins on the connector, pull the connector straight off (not at an angle). Make the cable connections while the connector is away from the unit, and then push the connector straight on (not at an angle) when the wiring is complete.

Proper connections and cabling are extremely important for accurate measurement. Use the correct cable type for each probe and make sure the cables are not damaged during installation. See the sections that follow for specific connection instructions.

## 1.9.2 Connecting the Input Power

To connect the input power, simply plug the power cable into the receptacle next to the **ON/OFF** switch at the lower left corner of the back panel (see *Figure 8 on page 15*). DC wiring is shown in *Figure 9* below.



**WARNING!** If the power mains switch on the unit remains accessible to the user after installation, a disconnect device is not required. However, if the installation blocks access to the power mains switch, compliance with the EU's Low Voltage Directive (IEC 61010) requires an external power disconnect device such as a switch or circuit breaker. The disconnect device must be marked as such, clearly visible, directly accessible, and located within 1.8 m (6 ft) of the unit.

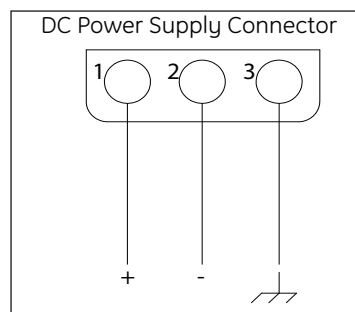

**Figure 10: DC Power Wiring**

## 1.9.3 Connecting Moisture Probes

The moisture.IQ uses *M-Series* and *Moisture Image Series* probes to measure moisture. If you need to connect a different probe type, please contact our technical support department. If you ordered one or more M-Series probes with the moisture.IQ, BHGE has entered the necessary probe setup data on a pre-assigned channel.

**IMPORTANT:** See the Calibration Data Sheets, shipped with the probes, to connect the probes to their corresponding channels. If a probe is connected to the wrong channel, the meter will display incorrect data.

Probes are identified on the *Calibration Data Sheet* by a serial number. The serial number is also engraved on the hex nut of the probe, as shown in *Figure 11* below.

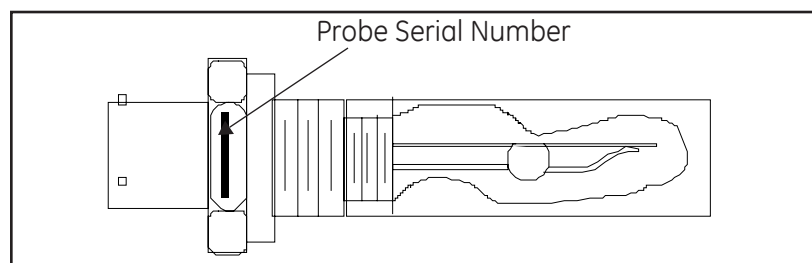

**Figure 11: Moisture Probe Serial Number**

The *Moisture Image Series* probe does not require any pre-programming, because it stores all the necessary setup data in its electronics module. Therefore, you can install a *Moisture Image Series* probe on any available channel. After you install the probe, you must activate the probe on the installed channel, as described in “*The Probe Configuration Screen*” on page 60. Proceed to the following sections to properly connect your moisture probes.

### 1.9.3.1 M-Series Probes

M-Series probes are primarily used for moisture measurement, but they can be used to measure temperature as well. If ordered, an optional temperature thermistor is included in the moisture probe and requires an additional connection.

If the M-Series probe does not have a thermistor, then you may use a two-wire shielded cable with a bayonet-type connector to connect the probe to the electronics unit. If an optional thermistor is installed, then use a four-wire shielded cable with a bayonet-type connector to connect the M-Series Probe to the electronics unit. The M-Series Probe may be located up to 600 m (2000 ft) from the moisture.IQ.

Before making the electrical connections, connect the cable to the probe by inserting the bayonet-type connector onto the probe and twisting the shell clockwise until it snaps into a locked position (approximately 1/8 of a turn). Wire the probe cable per the wiring diagram in *Figure 12* below. The M-Series terminal block on the back panel of the moisture.IQ (see *Figure 13* on page 18) also notes the corresponding color from the probe cable.

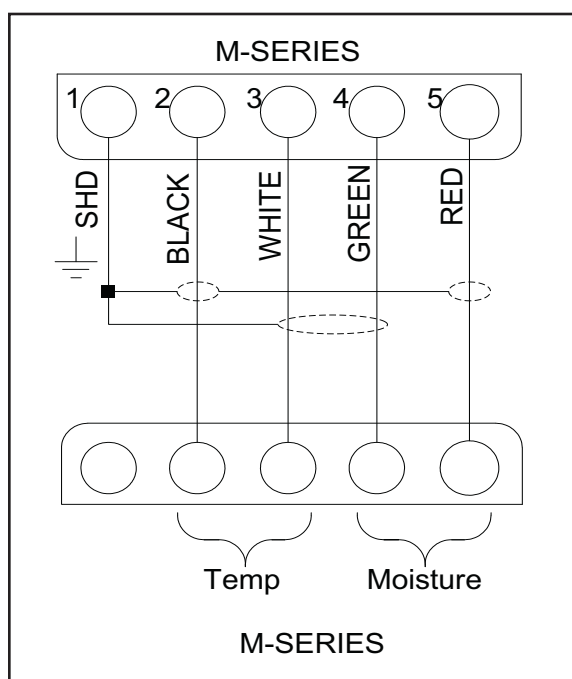

**Figure 12: M-Series Probe Cable Wiring Diagram**

**Note:** The label **SHD** in Figure 12 above corresponds to the **SH** label on the connector, and these terminals are used to terminate the cable shield.

1.9.3.1 M-Series Probes (cont.)

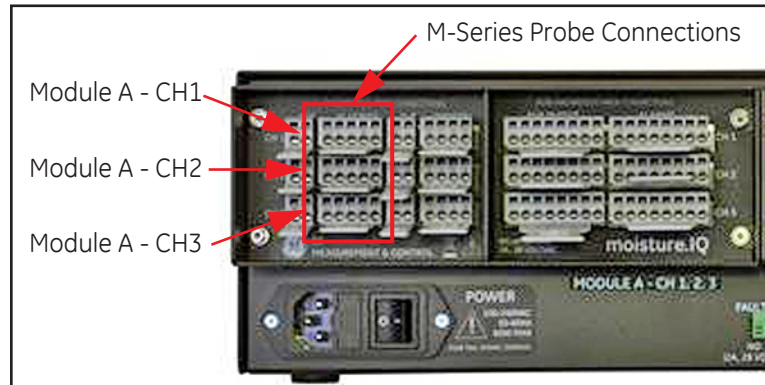

**Figure 13: M-Series Probe Connections**

**Note:** Additional M-Series probes may be connected to **CH4**, **CH5** and **CH6** in the **Module B** connector group on the right side of the back panel.

If you connect a probe to the wrong channel, you can either reconnect the probe to the assigned channel or reconfigure the current channel as described in “The Probe Configuration Screen” on page 60.



**WARNING!** The M-Series probe may not be capable of withstanding the 500V insulation rating. This must be taken into account in any installation in which it is used.

### 1.9.3.2 Moisture Image Series Probes (MISP and MISP2)

Connect the *Moisture Image Series* probes (**MISP**) to the moisture.IQ using the cable provided. You can locate a *Moisture Image Series* probe up to 915 m (3000 ft) from the electronics unit.

**Note:** *Sale of the MISP probe was discontinued by BHGE in 2010 and it was replaced by the MISP2 probe. Although the MISP probe can be used successfully with the moisture.IQ analyzer, there may be communication issues when using long cables.*

Before making any electrical connections, you must assemble the probe. A *Moisture Image Series* probe may be shipped in two parts: a **probe** and an **electronics module**, each of which has its own serial number. If you ordered more than one probe, be sure to match each probe to its matching electronics module using the serial numbers listed on the probe *Calibration Data Sheet*. To assemble a *Moisture Image Series* probe, insert the probe into the probe connector on the matching electronics module and turn the probe counterclockwise until it locks in place (see *Figure 14* below).

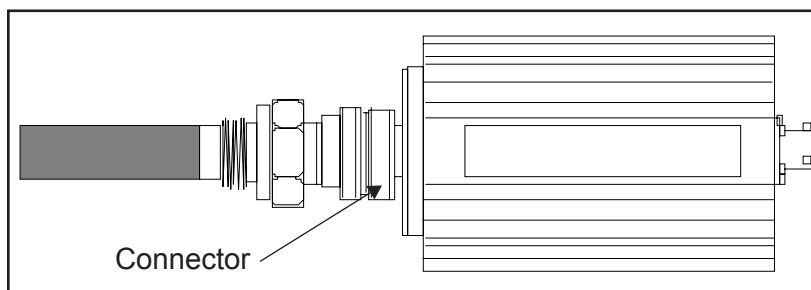

**Figure 14: Moisture Image Series Probe (MISP) Assembly**



**CAUTION!** The MISP2 probe has an integral set of electronics permanently attached (see *Figure 15* below). Do not attempt to separate an MISP2 probe from its electronics.



**Figure 15: MISP2 Probe**

### 1.9.3.2 Moisture Image Series Probes (cont.)

If the *Moisture Image Series* probe requires assembly, complete that task before proceeding. Then, connect the probe cable to the terminal block labeled MIS on the back panel of the electronics unit (see *Figure 16* below).

You can connect the *Moisture Image Series Probe* to any channel. However, if you are also using other sensors such as M-Series probes, be sure to connect the *Moisture Image Series* probe to an unassigned channel.

**IMPORTANT:** Check the Calibration Data Sheets of all installed sensors to determine which channels already have probes assigned to them.

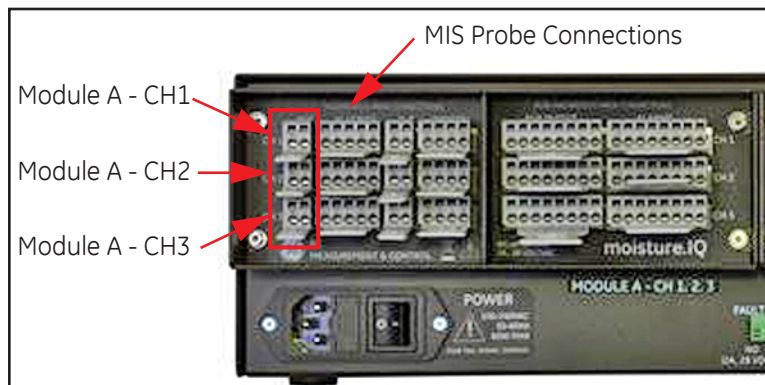
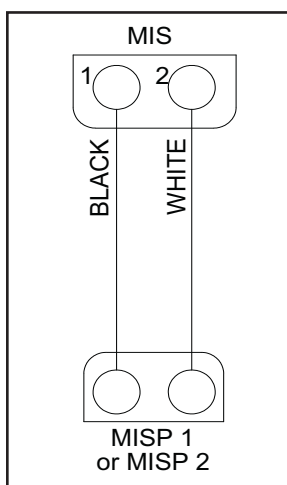

**Figure 16: MIS Probe Connections**

**Note:** Additional MIS probes may be connected to **CH4, CH5 and CH6** in the **Module B** connector group on the right side of the back panel.

After you make the back panel connections, connect the other end of the probe cable to the *Moisture Image Series* probe per the wiring diagram in *Figure 17*. Trim all other flying leads from the cable flush with the jacket.

After you complete the *Moisture Image Series* probe connections, you must activate the probe on the installed channel as described in “The Probe Configuration Screen” on page 60.



**Figure 17: MIS Probe Cable Wiring Diagram**



### 1.9.4 Connecting the Delta F Oxygen Cell

The *Delta F Oxygen Cell* is available in a general-purpose model with standard or VCR<sup>®</sup> fittings. The oxygen cell can also be mounted in a weatherproof enclosure (R4) for outdoor applications or an explosion-proof enclosure (R7) for use in hazardous areas.



**CAUTION!** Do not power up the moisture.IQ without first establishing a gas flow through the Delta F Oxygen Cell (see “Establishing a Gas Flow Through the Oxygen Cell” on page 26).

Each *Delta F Oxygen Cell* has a set of sensor electrodes and a set of secondary electrodes. For proper operation, make connections to each set of electrodes using a six-wire shielded cable. BHGE provides the **704-1357-B-Z** cable with 22 AWG conductors for use with *Delta F Oxygen* cells.

**Note:** Cable with 16 AWG conductors is the largest cable size that can be easily installed into the moisture.IQ terminal blocks and the Delta F sensor terminal posts.

Cable error is a function of cable resistance/foot, length of cable, and maximum sensor current output. Since higher range sensors have a greater current output, they have shorter acceptable cable lengths. Larger gauge cable results in longer acceptable cable lengths. Use *Table 1* below to determine acceptable installation lengths for your application.

**Table 1: Acceptable Cable Lengths for Delta F Ranges**

Delta F Sensor Range	Cable Gauge	Max Length
0-50 ppm and 0-100 ppm	22 AWG	1300 ft
0-1000 ppm	22 AWG	400 ft
0-10,000 ppm and greater	22 AWG	100 ft
0-50 ppm and 0-100 ppm	20 AWG	2100 ft
0-1000 ppm	20 AWG	630 ft
0-10,000 ppm and greater	20 AWG	160 ft
0-50 ppm and 0-100 ppm	18 AWG	3300 ft
0-1000 ppm	18 AWG	1000 ft
0-10,000 ppm and greater	18 AWG	250 ft
0-50 ppm and 0-100 ppm	16 AWG	6600 ft
0-1000 ppm	16 AWG	2000 ft
0-10,000 ppm and greater	16 AWG	500 ft

### 1.9.4 Connecting the Delta F Oxygen Cell (cont.)

Instructions for connecting each type of oxygen cell are described in the following sections. If you are installing the oxygen cell in an intrinsically safe area, refer to the following sections for special installation requirements.



**WARNING!** The Delta F Oxygen Cell is BASEEFA approved for use in intrinsically safe areas when connected to a BASEEFA approved moisture.IQ hygrometer. Install the apparatus so that the terminals are protected to at least the requirements of IP20. Copies of official BASEEFA documentation (certificates of compliance, licenses, etc.) are to be made in their entirety.

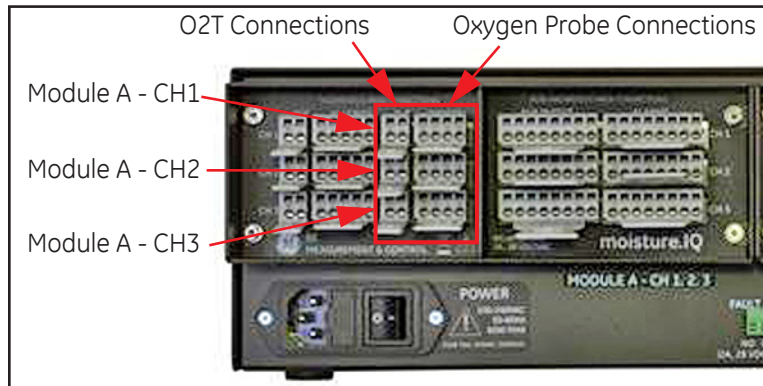

**Figure 18: Delta F Oxygen Cell Connections**

**Note:** Additional Delta F Oxygen cells may be connected to **CH4, CH5 and CH6** in the **Module B** connector group on the right side of the back panel.

**Note:** For moisture.IQ Fiberglass Weatherproof installation with optional Delta F sensors, clamp a ferrite bead GE P/N 222-031 to each Delta F cable on the inside of the enclosure.

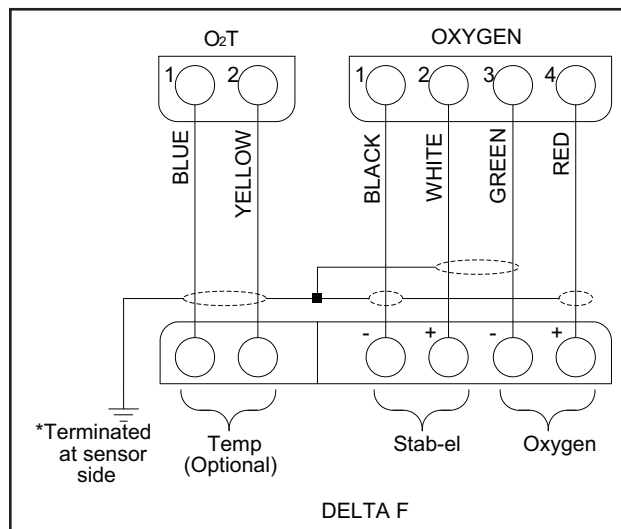

**Figure 19: Delta F Oxygen Cell Wiring**

### 1.9.4.1 Standard Delta F Oxygen Cells

Figure 20 below shows a standard *Delta F Oxygen Cell* and identifies the *sensing* and *secondary* electrodes. Make oxygen cell connections from the electrodes on the oxygen cell to the **OXYGEN** terminal block on the back of the moisture.IQ. Refer to *Figure 18* on page 22 and *Table 2* below for the required connections.

**IMPORTANT:** To maintain good contact at each terminal block and to avoid damaging the pins on the connector, pull the connector straight off (not at an angle), make cable connections while the connector is away from the unit, and push the connector straight on (not at an angle) when the wiring is complete.

**Table 2: Standard Delta F Oxygen Cell Connections**

Connect:	To Delta F Oxygen Cell:	To moisture.IQ OXYGEN Terminal Block
red wire	+ sensing electrode	pin 4 RD
green wire	- sensing electrode	pin 3 GR
white wire	+ secondary electrode	pin 2 WT
black wire	- secondary electrode	pin 1 BK
shield	Earth Ground Connection	---

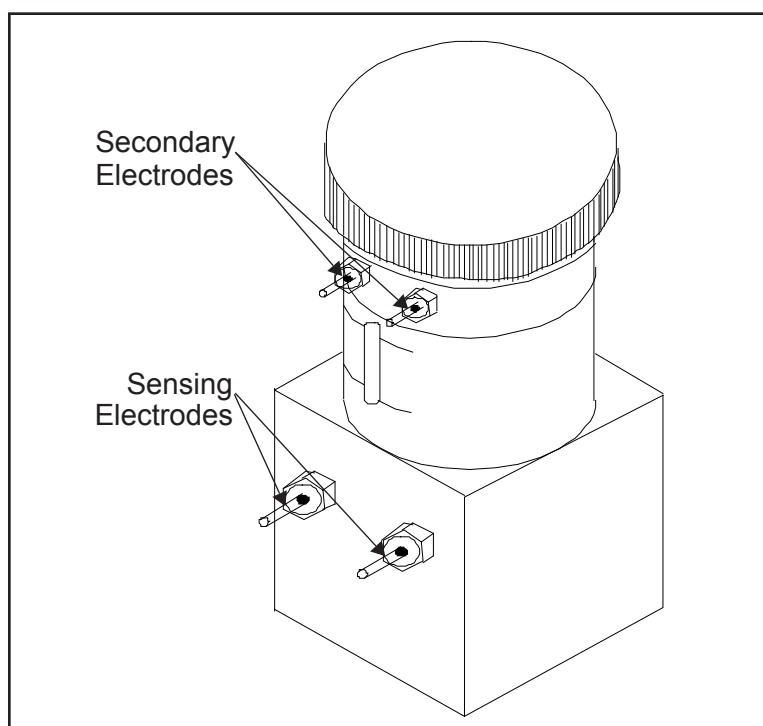

**Figure 20: Standard Delta F Oxygen Cell**

**Note:** The temperature reading of the sensor is used for internal temperature compensation and does not require any user setup.

### 1.9.4.2 Weatherproof Delta F Oxygen Cells

The weatherproof oxygen cell has a set of sensing and secondary electrodes that are wired to a terminal strip in the weatherproof enclosure. Connect the weatherproof oxygen cell using a four-wire shielded cable with a mating bayonet-type connector. Fasten the bayonet-type connector to the mating connector on the bottom of the weatherproof enclosure. Connect the other end of the cable to the **OXYGEN** terminal block on the back of the moisture.IQ. Refer to *Figure 18 on page 22* and *Table 3* below for the required connections.

**Table 3: Weatherproof Delta F Oxygen Cell Connections**

<b>Connect:</b>	<b>To Delta F Enclosure Terminal Block</b>	<b>To moisture.IQ OXYGEN Terminal Block</b>
red wire (+)	pin 1	pin 4
green wire (-)	pin 2	pin 3
white wire (+)	pin 3	pin 2
black wire (-)	pin 4	pin 1

### 1.9.4.3 Explosion-proof Delta F Oxygen Cells

Figure 21 below shows the explosion-proof oxygen cell. The oxygen cell has a set of sensing and a set of secondary electrodes that are wired to a terminal strip in the explosion-proof enclosure. Connect the explosion-proof oxygen cell using a four-wire shielded cable. Connect one end of the cable to the **OXYGEN** terminal block on the back of the moisture.IQ and the other end to the terminal strip in the oxygen cell enclosure. Feed the cable wires through one of the cable ports in the side of the explosion-proof enclosure. Refer to Figure 18 on page 22 and Table 4 below for the required connections.

**Table 4: Explosion-proof Oxygen Cell Connections**

Connect:	To Oxygen Cell Terminal Block	To moisture.IQ OXYGEN Terminal Block:
red wire (+)	pin 1	pin 4
green wire (-)	pin 2	pin 3
white wire (+)	pin 3	pin 2
black wire (-)	pin 4	pin 1

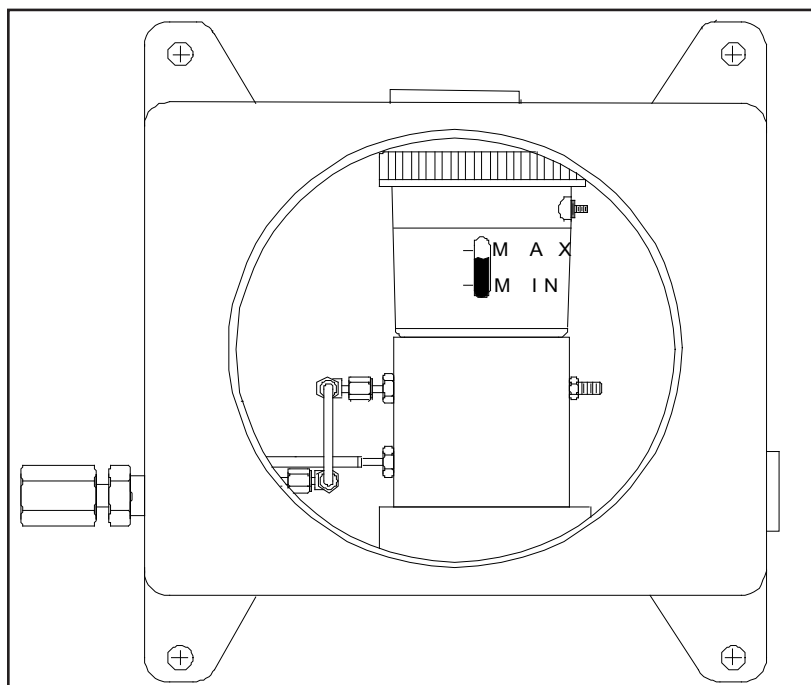

**Figure 21: Explosion-Proof Delta F Oxygen Cell**

## 1.10 Establishing a Gas Flow Through the Oxygen Cell



**CAUTION!** Establish a gas sample flow through the *Delta F Oxygen Cell* before you power up the system or damage may occur to the oxygen cell.

**Note:** *If you are not using a Delta F Oxygen Cell in your system, skip this section and proceed to the following chapters to configure your system.*

The *Delta F Oxygen Cell* requires a gas flow rate of 2 to 2.5 SCFH through the cell. The oxygen cell inlet pressure should be between 0.2 and 1.0 psig. Refer to *Figure 22 on page 27* when establishing a gas sample flow.



**CAUTION!** Do not operate the Delta F oxygen cell for extended periods of time at oxygen concentrations that are over range. Trace and low percent range sensors may be damaged if exposed to high levels of oxygen, such as air, for long periods (>1 hour) while the moisture.IQ is in operation. If exposure is unavoidable, either disconnect the oxygen cell from the moisture.IQ or equip the sample system with a valve that allows the cell to be switched to a purge gas.

1. Close the flow control valve and adjust the upstream pressure as required. BHGE recommends a pressure of about 2 to 10 psig pressure upstream from the flow control valve, depending on what type of valve is installed in the sample system.
2. To safeguard against over pressurizing the oxygen cell, install a relief valve rated at 10 psig in the gas flow system. There should be no restrictions downstream from the oxygen cell. Use 1/4 inch tubing or larger on the oxygen cell outlet and the relief valve outlet. Both outlets should vent to atmosphere if possible.



**CAUTION!** Do not connect the relief valve and oxygen cell outlets to a common outlet line smaller than 1/4 inch. This pressure restriction will damage the oxygen cell. In addition, a relief valve should be installed in the oxygen sample system. If either of these conditions are not met, the Delta F Oxygen Cell warranty will be voided.

## 1.10 Establishing a Gas Flow Through the Oxygen Cell (cont.)

3. Slowly open the flow control valve until the recommended flow of 2 to 2.5 SCFH is established on the flow meter.
4. When the proper flow is achieved, make sure the relief valve is closed by placing an object (e.g., your finger, if the gas is non-corrosive) over the relief valve vent. Cover and uncover the relief valve vent and verify that the flow meter shows no change in the flow rate. Keep the relief valve closed during operation to minimize leakage in the sample system.

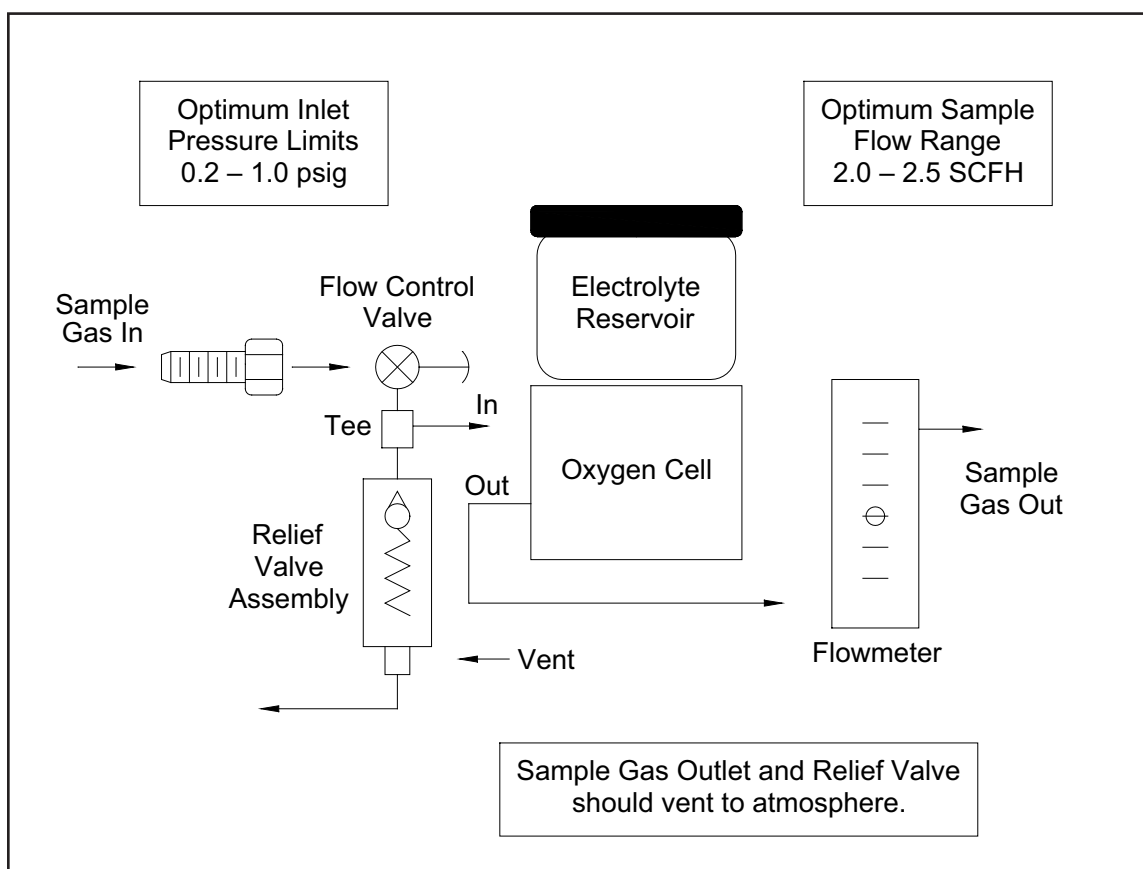

**Figure 22: Gas Flow Schematic**

### 1.11 Connecting an Auxiliary Device

moisture.IQ can power an auxiliary device (such as a loop power transmitter) in which the connection is +24V to Aux 1 or 2. For external power devices with output directly connected to the auxiliary device, you can use aux 1 or 2 with respect to RTN (pin 5). Make the connections to the right-side group of probe connections (**AUX IN/OUT** and **ALARMS**) that are rated for non-hazardous area use. Users set the voltage/current for the auxiliary input and the electronics will automatically switch the circuits, so the moisture.IQ has no physical switch to toggle. *Figure 23* and *Figure 24* below show the connections and wiring for auxiliary devices.

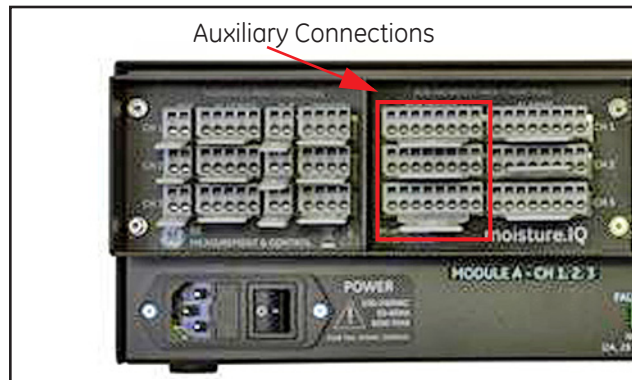

**Figure 23: Auxiliary Connections**

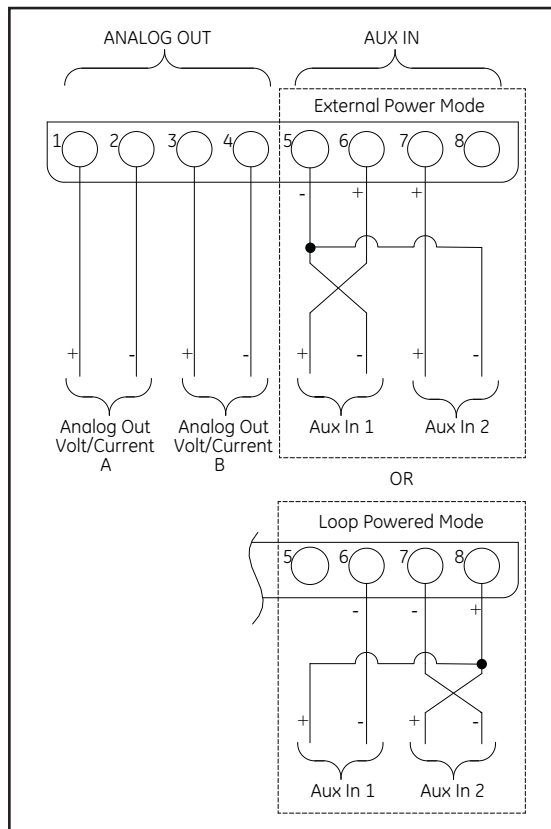

**Figure 24: Auxiliary Device Wiring Diagram**



**Note:** If you are connecting the oxy.IQ to AUX-IN, the oxy.IQ's shield needs to be terminated to the moisture.IQ via RTN (pin 5). In order to expose the shield wire, strip back the cable jacket.

## 1.12 Connecting Analog Outputs

The moisture.IQ has two Analog Outputs per channel. Connect the outputs to the terminal blocks, labeled REC A and REC B. See *Figure 23* for the terminal block location and *Figure 25* for the wiring diagram. Make connections for recorders using *Table 5*.

**Table 5: Output Connections**

Connect Output A	To REC Terminal Block
return (-)	pin A-
out (+)	out (+)
Connect Output B	To REC Terminal Block
return (-)	pin B-
out (+)	pin B+

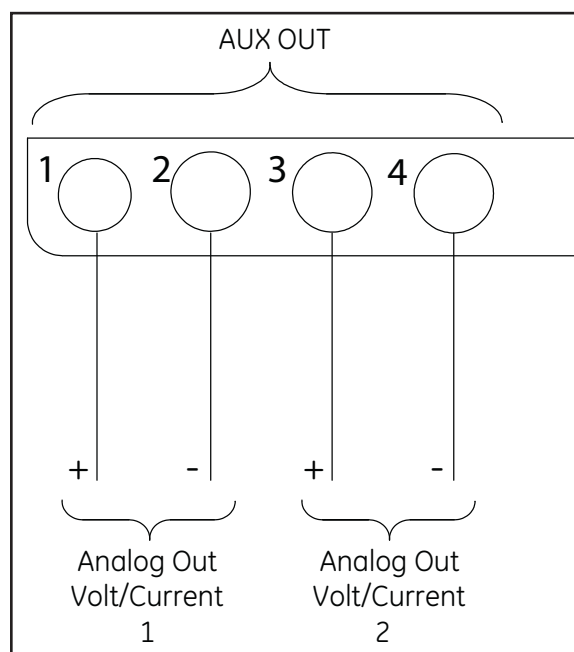

**Figure 25: Output Wiring**

## 1.13 Connecting Alarms

**Note:** Customers must provide their own cables for connecting alarm relays. Acceptable cables range from 12 to 24 AWG.

The moisture.IQ has two high/low alarm relays per channel. There is also one system fault alarm relay, which is not channel specific. Each alarm relay has single-pole, double-throw contacts that consist of the following:

- Normally Open (NO)
- Common (C)
- Normally Closed (NC)

Table 6 and Figure 26 below list alarm wiring connections.

**Table 6: Pin Designations for Relay Contacts**

Description	Fault	Alarm A	Alarm B
Normally Open	1	1	6
Common	2	2	7
Normally Closed	3	3	8

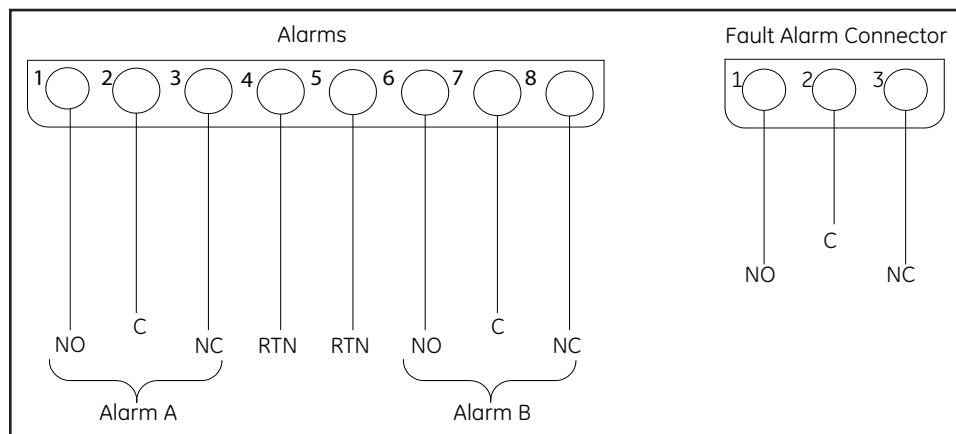

**Figure 26: Alarm Wiring**

## Chapter 2. Operation

### 2.1 Powering Up

After completing the installation of your system, as described in *Chapter 1. “Installation” on page 1*, power up the moisture.IQ with the **ON/OFF** switch located at the lower left corner of the back panel. You will observe the following display screens in sequence:

1. A black screen with a large GE monogram in the center.
2. A black screen with a GE monogram and the “moisture.IQ” name, along with a blue progress bar along the right edge of the screen.
3. A measurement display screen, similar to that shown in *Figure 27* below.

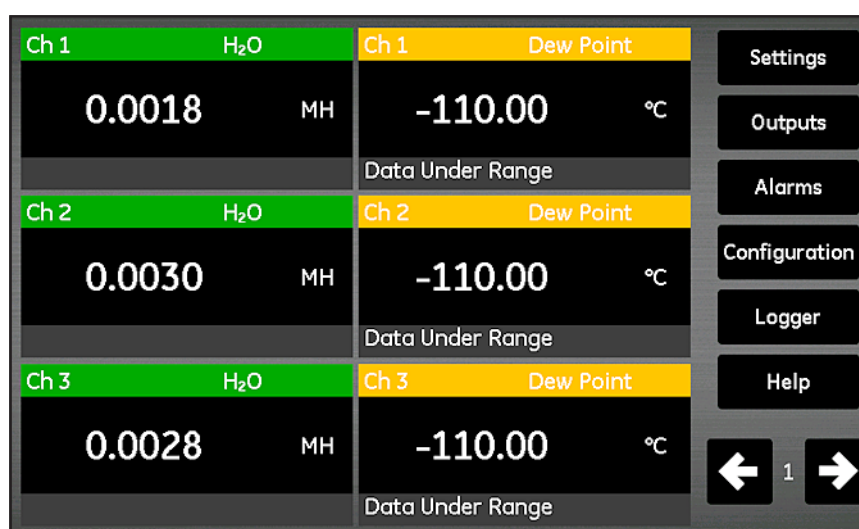

**Figure 27: Measurement Display Screen**

**Note:** *The moisture.IQ is equipped with an automatic cooling fan. This fan will activate as needed to maintain the proper temperature inside the enclosure. The periodic sound of this fan running is normal.*

### 2.2 Measurement Display Components

The measurement display screen shown in *Figure 27* above is a touch screen which includes the following items:

- Either 6 or 12 *measurement displays* per screen (depending on your display configuration settings)
- The *main menu* for programming the moisture.IQ, consisting of the 6 options shown
- *Left and Right* arrows, with a page number between them, which are used to scroll through the pages of measurement displays (6 pages of 6 measurements/page or 3 pages of 12 measurements/page)

To access any of the screen components, simply tap on the desired item with your finger tip.

### 2.3 The Help Button

In the main menu on the right side of the measurement display screen and on every other moisture.IQ programming screen, a **Help** button is available to provide the user with detailed information on that specific screen or menu option. A sample **Help** screen from the *Probe Configuration* menu is shown in *Figure 28* below.

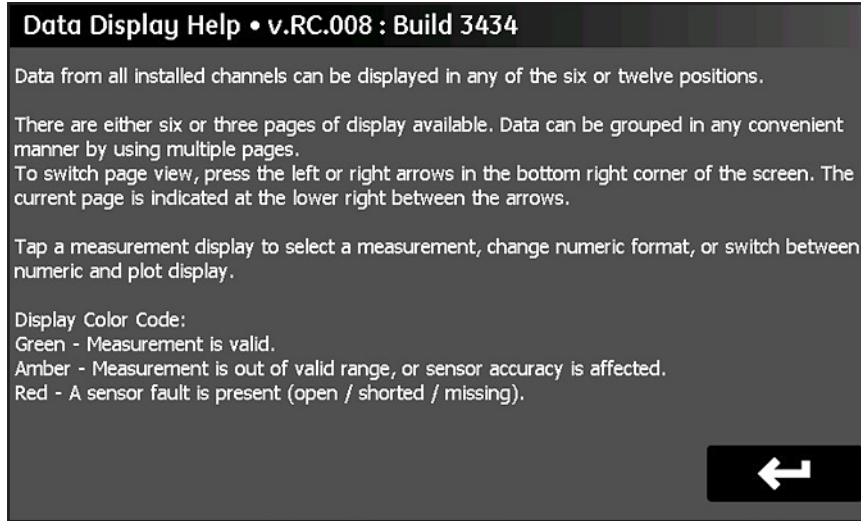

Figure 28: Data Display Help Screen

To access the context-sensitive help information for any screen, just tap the **Help** button on that screen.

### 2.4 The Data Element Editor

The display of any of the 36 data measurements available from the main screen may be individually configured by tapping on the desired measurement display. This will open a *Data Element Editor* screen similar to that shown in *Figure 29* below.

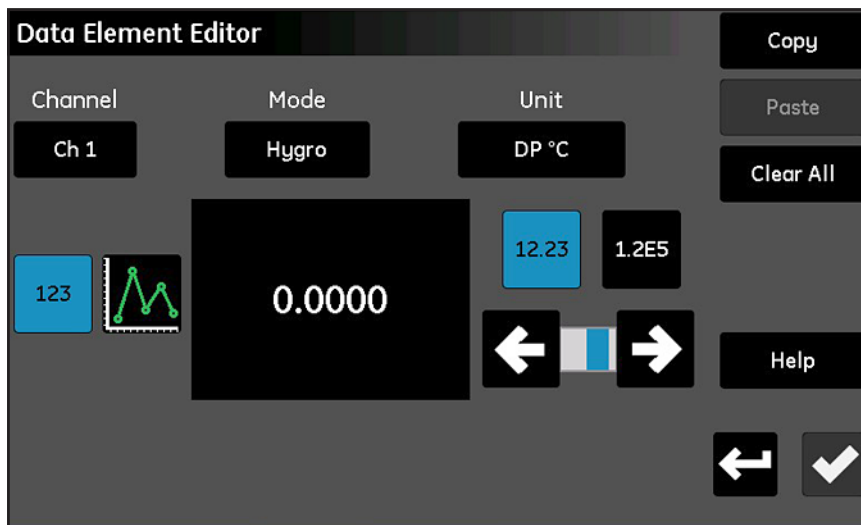

Figure 29: The Data Element Editor Screen



## 2.4 The Data Element Editor (cont.)



As shown in *Figure 29 on page 32*, the following settings are available for the display:

- **Channel:** Select the channel (1-6) to be displayed.
- **Mode:** Select the measurement type (Hygro, Pressure, Temperature, Oxygen, Aux 1, Aux 2 or Function) to be displayed.
- **Unit:** Select the units of measure to be displayed.
- **123/Graph:** Toggle between a *Numeric* and *Graphical* display.

**Note:** *The error message is only available in numeric mode – not in graphical mode.*

- **12.23/1.2E5:** Toggle between *Floating Point Decimal* and *Scientific* numeric displays.
- **Slider Bar:** Use the Left and Right arrows to select the number of *decimal places* for the numeric display.
- **Copy and Paste:** Use these buttons to duplicate display settings from one measurement display to another.
- **Clear All:** Use this button reset the display to the default state.

**Note:** *The current selection for the toggled items is highlighted in blue.*

As with all of the moisture.IQ programming screens, tap the **Check** button  to save your new settings, or tap the **Cancel** button  to keep the previous settings.

## 2.5 Initial Setup

Before you can obtain accurate measurement data, you must properly configure the moisture.IQ and all attached probes. This is accomplished by using the *Main Menu* options along the right side of the measurement display screen. Simply tap the desired menu item on the touch screen to access that particular menu, and proceed to the appropriate chapter in this manual for detailed instructions.

After your initial setup is complete, these same menus can be used to program the moisture.IQ with your personal preferences and to reconfigure the unit whenever there are any changes in your system.

**Note:** *Initially, all menus are locked at startup. After you enter a password, these menus will be unlocked, but will timeout (and relock) after 15 minutes with no activity.*

## 2.6 Restarting the System

To restart the moisture.IQ, complete the following steps:

1. Tap the *Settings Menu* button on the right side of the touch screen.
2. Tap the **Restart** button in the *Service* section of the touch screen.
3. At the confirmation screen shown in *Figure 30* below, tap the **Yes** button to restart the unit or tap the **No** button to cancel the request.

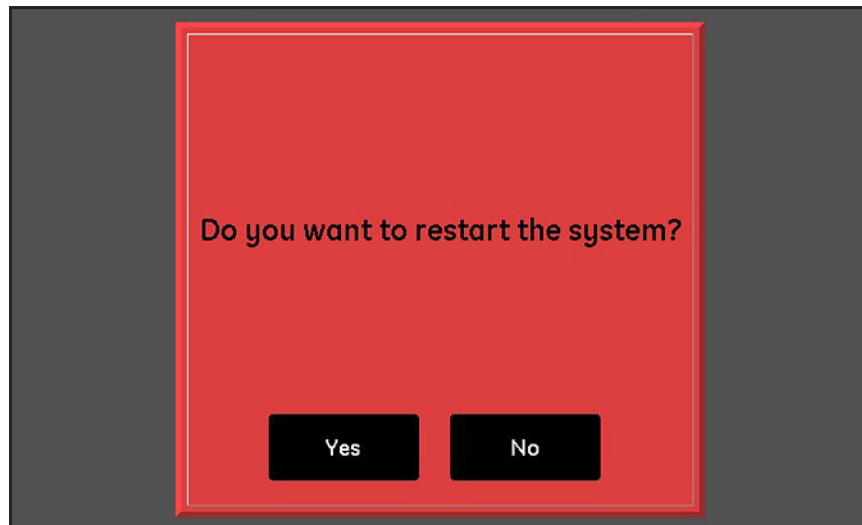
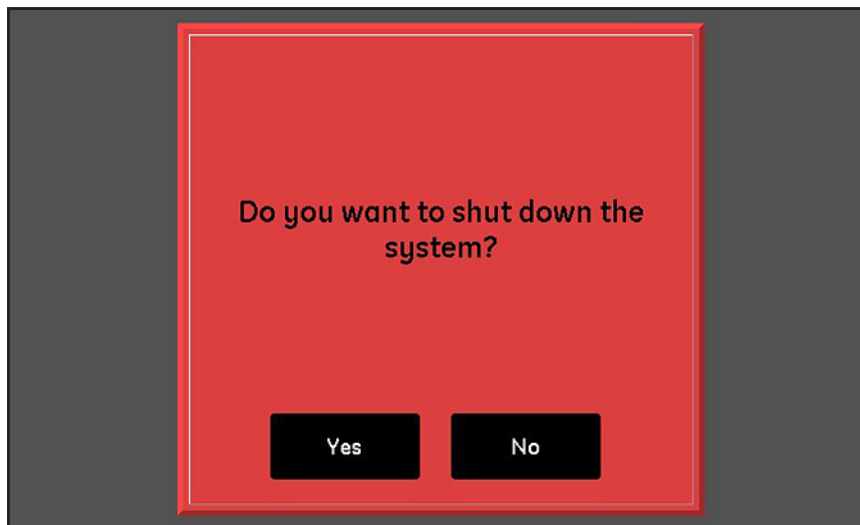

**Figure 30: Restart Confirmation Screen**

## 2.7 Shutting Down the System

To shut down the moisture.IQ, complete the following steps:

1. Tap the *Settings Menu* button on the right side of the touch screen.
2. Tap the **Shut Down** button in the *Service* section of the touch screen.
3. At the confirmation screen shown in *Figure 31* below, tap the **Yes** button to shut down the unit or tap the **No** button to cancel the request.
4. After the message “*It is now safe to shut down the unit*” is displayed on the touch screen, use the **On/Off** power switch at the lower left corner of the back panel to shut down the moisture.IQ.



**Figure 31: Shut Down Confirmation Screen**







## Chapter 3. Using the Settings Menu

### 3.1 Introduction

After completing the installation of your moisture.IQ system (see *Chapter 1*) and powering up the system (see *Chapter 2*), you must configure the moisture.IQ before reliable data can be collected.

The *Settings* menu is used to configure the display and to program the desired system settings. Use the menu map in *Figure 76* on page 109 and the display touch screen shown in *Figure 32* below as guides while programming the *Settings* menu. To begin, tap the **Settings** menu button on the main measurement display screen, and proceed to the following sections for instructions.

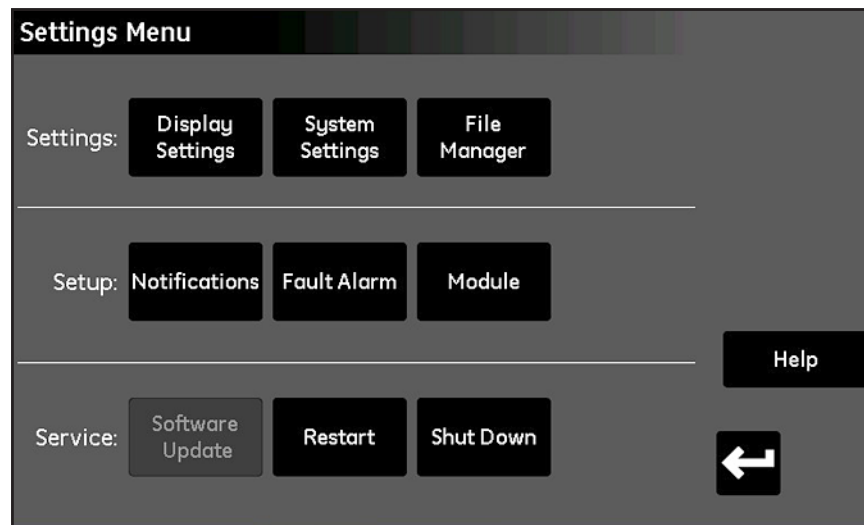

Figure 32: Settings Menu Screen

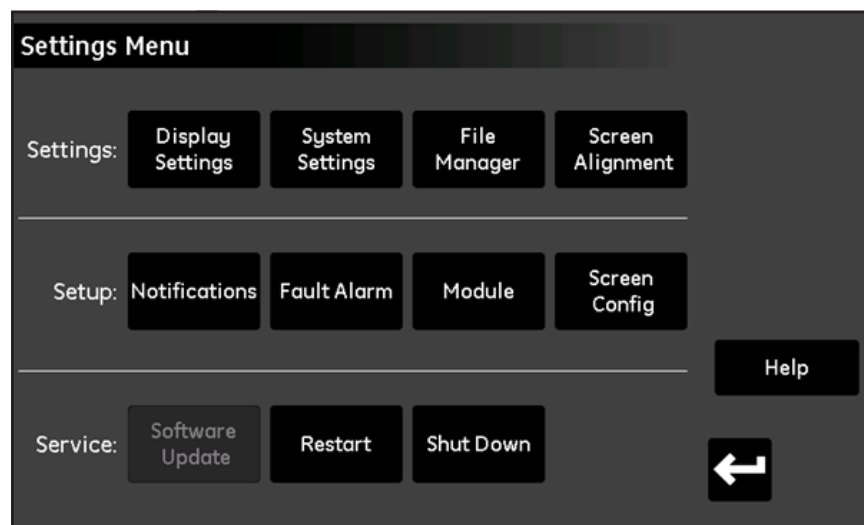
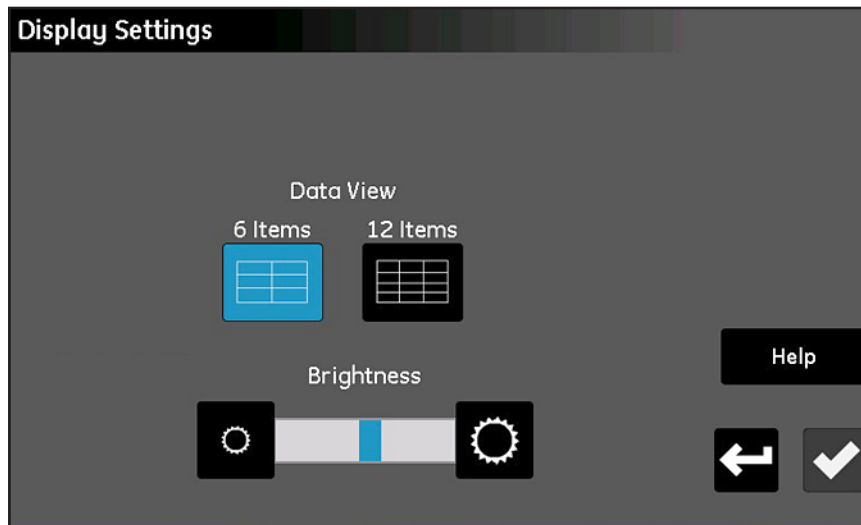

Figure 33: Settings Menu Screen for Explosion-Proof and Weatherproof

## 3.2 Display Settings

The *Display Settings* menu (see *Figure 34* below) allows you to configure the measurement screen.

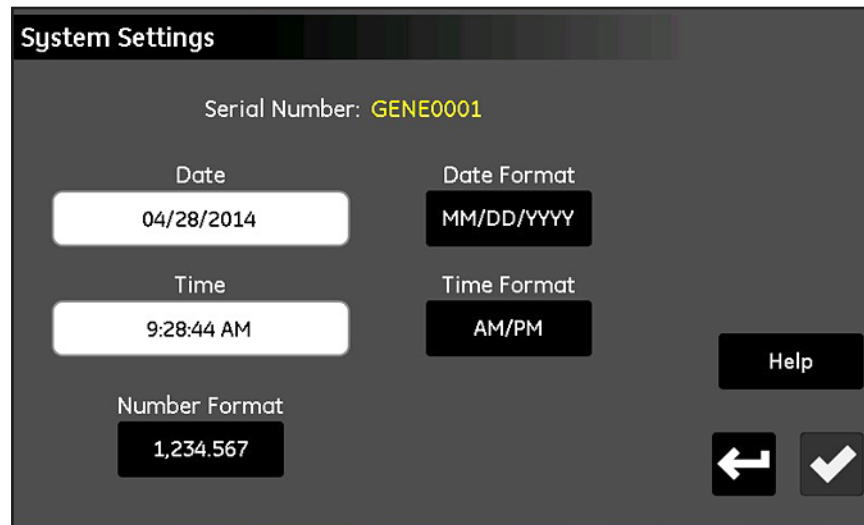

**Figure 34: The Display Settings Screen**

- Tap the **6 Items** or **12 Items** button to toggle between a main screen with 6 measurement displays or one with 12 measurement displays. The current setting is highlighted in blue.
- To adjust the screen brightness, tap the button at the right end of the **Brightness** slider to increase the screen brightness or the button at the left end of the slider to decrease the screen brightness, until the desired setting is achieved. The blue indicator bar on the slider indicates the current setting location.
- After completing your settings, either tap the **Check** button to save your changes, or tap the **Cancel** button to discard the changes and keep the original settings.

### 3.3 System Settings

The *System Settings* menu (see *Figure 35* below) allows you to configure the global moisture.IQ settings.



**Figure 35: The System Settings Screen**

- The system **Serial Number** is displayed as a *read-only* value at the top of the screen.
- Tap the **Date** button and select the current date from the pop-up calendar. Tap the **Date Format** button and select the desired format (**MM/DD/YYYY**, **DD/MM/YYYY** or **YYYY-MM-DD**) from the drop-down list.
- Tap the **Time** button and set the current time with the pop-up **Hours** and **Minutes** counters. Tap the **Time Format** button to toggle between the available formats (**24 Hr** or **AM/PM**).
- Tap the **Number Format** button and select either **1,234.567** or **1.234,567** from the drop-down list to specify the format for displaying numbers.
- After completing your settings, either tap the **Check** button to save your changes, or tap the **Cancel** button to discard the changes and keep the original settings. Then, tap the **Return** button to return to the *Settings Menu*.

**Note:** *If the Number Format is set to **1.234,567**, it is best to avoid using a Comma for the field separator in data logs.*

### 3.4 File Manager

The *File Manager* menu (see *Figure 36* below) enables you to view and manage any files stored in the moisture.IQ memory or in a connected USB drive. The most current site file is always named **moistureIQ.xml**, while the previous file is renamed to **moistureIQ.xml.backup**.

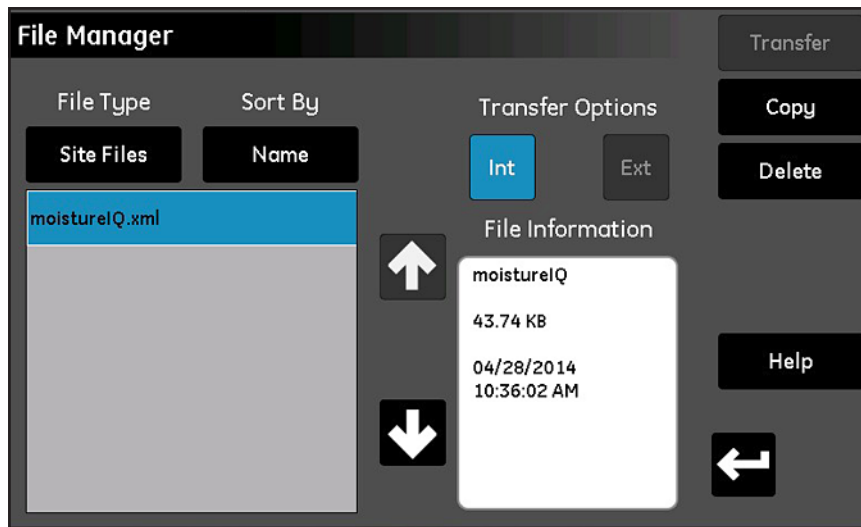
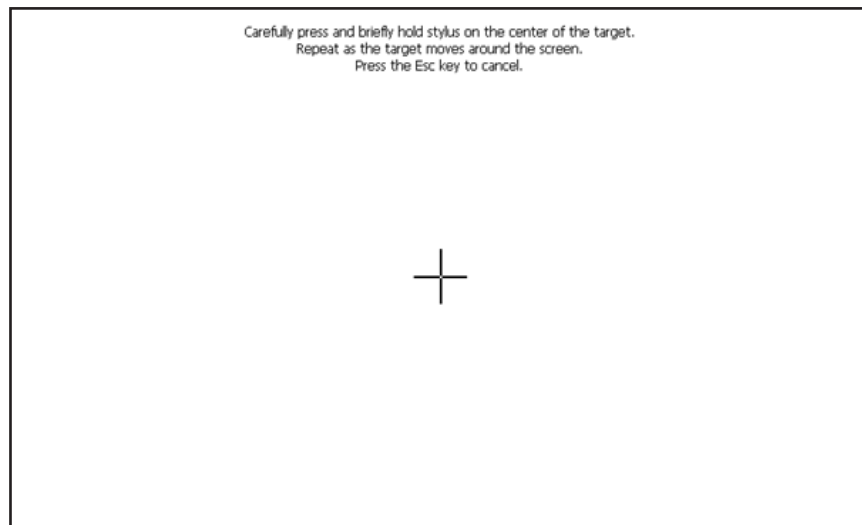

**Figure 36: The File Manager Screen**

- Tap the **File Type** button to open a drop-down list of options for selecting the type of files (**Log Files, Site Files, Cal Files, User Manual** or **Audit Log**) to be displayed.
- Tap the **Sort By** button to open a drop-down list of options for sorting the list of files (**Name, Date** or **Size**).
- Tap the name of any listed file to display detailed information about the file in the **File Information** box.
- With a file name highlighted, tap either the **Int** or **Ext** button under **Transfer Options** to specify the location for storing the selected file. **Int** stores the file to the internal moisture.IQ memory, while **Ext** (available only if an external USB drive is connected) stores the file to a USB drive connected to the moisture.IQ. The current location is highlighted in blue.
- As needed, tap the buttons in the upper right corner to **Delete** a file altogether, **Copy** it to another location or **Transfer** it to another location.
- The User Manual and Audit Log are read-only files that can be transferred to an external device, but not deleted.
- After completing your file management activities, tap the **Return** button to return to the *Settings* menu.

### 3.5 Screen Alignment (Weatherproof and Explosion-Proof)

The Screen Alignment feature is enabled for Weatherproof and Explosion-Proof versions of the moisture.IQ. This feature allows the user to calibrate the LCD screen to their touch and angles of usage to optimize touch screen performance.



**Figure 37: Screen Alignment**

- Touch the “+” symbol in its five locations: the middle and all four corners of the screen.
- After you have completed touching the locations, simply tap anywhere in the screen to complete the calibration.

**Note:** *Ignore the Enter/ESC instructions.*

### 3.6 Screen Configuration (Weatherproof and Explosion-Proof)

The Screen Configuration feature is enabled for Explosion-Proof and Weatherproof versions of the moisture.IQ. This feature allows the user to increase or decrease the touch screen's sensitivity based on the thickness of the protective window. Two other features allow for the touch screen's configuration in terms of X-axis and Y-axis to be flipped, but are only used in extremely rare cases. To adjust the screen's sensitivity based on thickness:

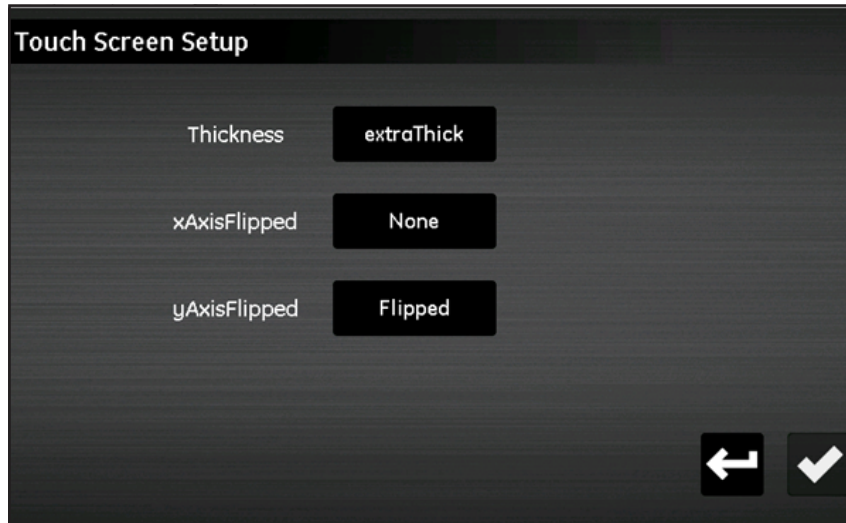

Figure 38: Screen Configuration

- Tap **Thick**.
- The existing setting will be highlighted in blue. Tap a setting above/below the current setting to decrease/increase the sensitivity of the screen.



### 3.7 Notifications Setup

The *Notifications Setup* menu (see *Figure 39* below) allows you to specify how often the moisture.IQ will display calibration reminders.

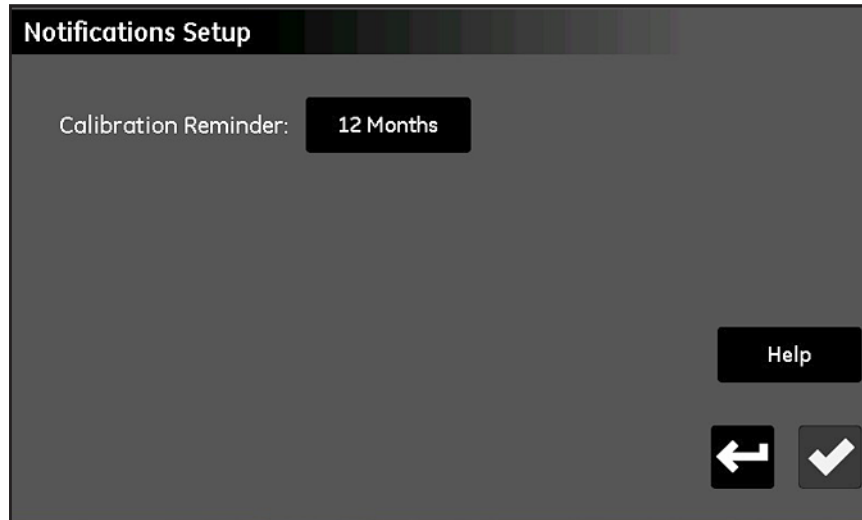
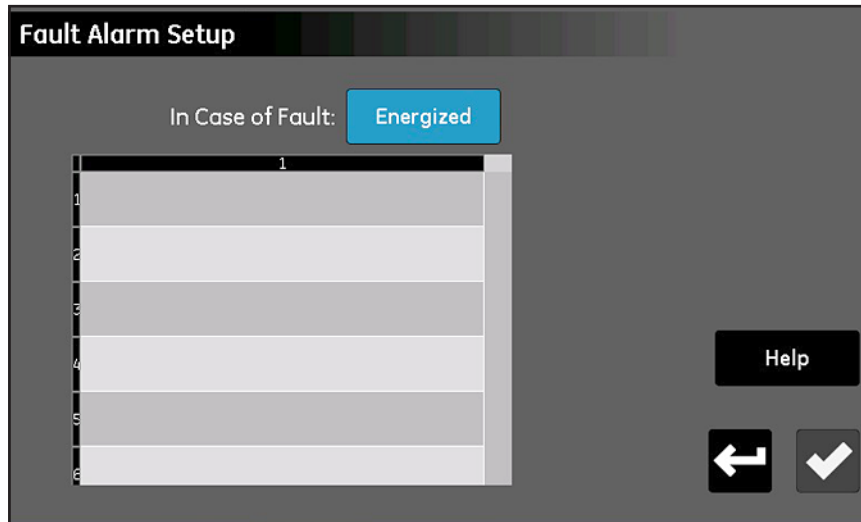

**Figure 39: The Notifications Setup Screen**

- Tap the **Calibration Reminder** button to open a drop-down list of options for selecting the interval (**None, 6 Months, 12 Months, 18 Months or 24 Months**) between automated reminder notifications.
- After completing your selection, either tap the **Check** button to save your changes, or tap the **Cancel** button to discard the changes and keep the original settings. In either case, you will be returned to the *Settings Menu*.

### 3.8 Fault Alarm Setup

The *Fault Alarm Setup* menu (see *Figure 40* below) allows you to specify how the moisture.IQ dedicated fault alarm relay responds to a fault condition and it lists the source of any current fault conditions.



**Figure 40: The Fault Alarm Setup Screen**

- Tap the **In Case of Fault** button to toggle between the **Energized** and **DeEnergized** options. This selection determines whether the relay is **Energized** or **DeEnergized** (fail-safe operation) when a fault condition is detected. The source of a fault is displayed in the fault list in *Figure 40* above.

**Note:** *The fault alarm relay is tripped whenever any sensor is open, shorted or disconnected. It will also trip when an overheating condition is detected.*

- After completing your selection, either tap the **Enter** button to save your changes, or tap the **Cancel** button to discard the changes and keep the original settings. In either case, you will be returned to the *Settings Menu*.

### 3.9 Module Setup

The *Module Setup* menu (see *Figure 41* below) is primarily a read-only screen. It provides detailed information on the currently installed sensor modules.



**Figure 41: The Module Setup Screen**

- The **Serial Number** and the current **Firmware Version** for the installed modules are listed at the top of the screen.
- Below the data boxes, the **Module Letter** and the **Available Channels** for each sensor module are listed.
- When an external USB drive containing a sensor module firmware update file is connected to the moisture.IQ, the **Update Firmware** button is enabled. To update the sensor module firmware, tap the **Module** to be updated and then tap the **Update Firmware** button. The module firmware will be updated and the system will reboot automatically.
- After you have finished reading the information on this screen, tap the **Return** button to return to the *Settings Menu*.

## 3.10 Service Menu Options

This menu includes the three options described below.

### 3.10.1 Software Update

When an external USB drive containing a moisture.IQ software update file is connected, the **Software Update** button will be enabled. Proceed as follows:

1. Tap the **Software Update** button.
2. Tap **Yes** at a screen similar to *Figure 42* below to confirm your choice, or tap **Cancel** to abort the update.
3. The new software will be installed automatically and you will be prompted to tap a **Restart** button to complete the process.

**Note:** *Your system configuration settings will not be affected by the software update.*

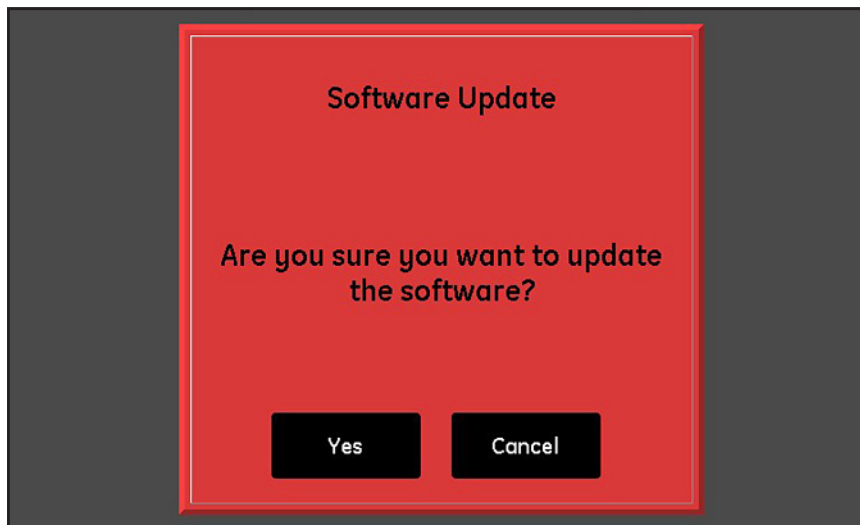

**Figure 42: Software Update Confirmation Screen**

### 3.10.2 Restart

To restart (i.e., reboot) the moisture.IQ system, tap the **Restart** button. Then, tap either **Yes** or **No** at a confirmation screen similar to the one shown in *Figure 30* on page 35.

### 3.10.3 Shut Down

To shut down the moisture.IQ system, tap the **Shut Down** button. Then, tap either **Yes** or **No** at a confirmation screen similar to the one shown in *Figure 31* on page 36.

## Chapter 4. Using the Outputs, Alarms and Logger Menus

### 4.1 Setting Up the Outputs

#### 4.1.1 Configuring an Output

**Note:** An active output is indicated by a “Play” symbol, and the alarm selected for editing is highlighted in yellow. A dashed border around an output indicates that the channel is not installed.

The moisture.IQ features two isolated analog outputs (A and B) for each of its six channels. To configure these outputs, refer to the menu map in *Figure 77 on page 110* and tap the **Outputs** button on the right side of the main touch screen to open a screen similar to that shown in *Figure 43* below.

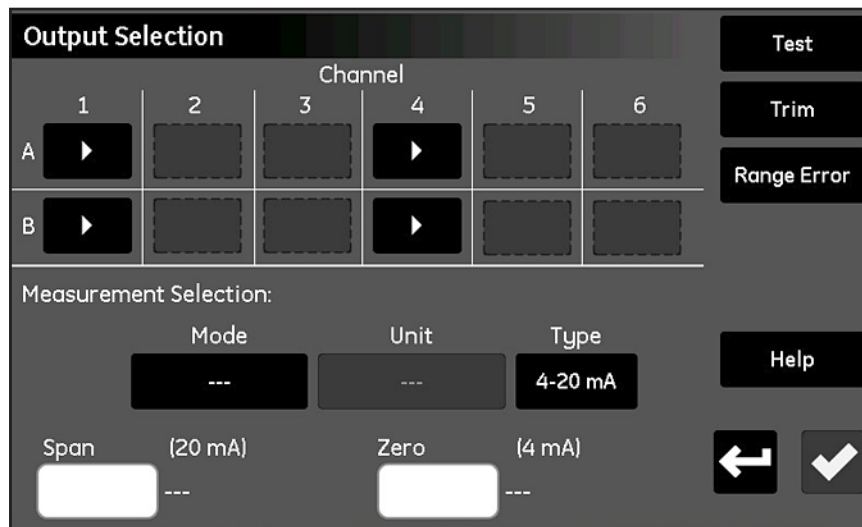

**Figure 43: Outputs Selection Screen**

1. Tap the button for the desired **Channel** (1-6) and **Output** (A or B).
2. In the *Measurement Selection* section, tap the **Mode**, **Unit** and **Type** (Current or Voltage) buttons to enter the desired settings for the output. (For available modes and units, refer to *Table 8 on page 61*.)
3. Tap the **Zero** box and enter the zero value via the keypad.
4. Tap the **Span** box and enter the span value via the keypad.
5. Tap the **Check** button to save your settings.

### 4.1.2 Testing the Selected Output

Make sure the output device is connected to the moisture.IQ as described in *Chapter 1, "Installation"* and complete the following steps to test the output:

1. Tap the **Channel (1-6)** and **Output (A or B)** to be tested, and then tap the **Test** button to open a screen similar to *Figure 44* below.

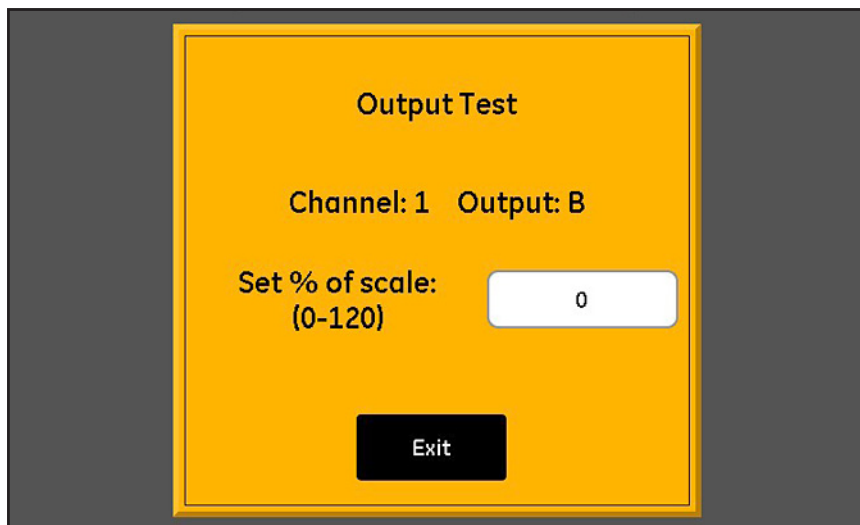

**Figure 44: Output Test Screen**

2. Tap the text box and enter the desired *Percent of Scale* test value (0-120). Then, tap the **Check** button to send the test value to the output.
3. After about 5 seconds, this reading should be as shown in *Table 7* below.

**Table 7: Expected Multimeter Test Readings**

Output Range	Multimeter Reading
0 to 20 mA	$20 \times \text{Test \%}/100 \text{ mA}$
4 to 20 mA	$4 + 16 \times \text{Test \%}/100 \text{ mA}$
0 to 2V	$2 \times \text{Test \%}/100 \text{ V}$

4. Repeat steps 1-3 for as many different test values as desired. When you have finished testing the output, tap the **Exit** button to return to the *Output Selection* screen.

### 4.1.3 Trimming the Selected Output

The measured value of the outputs can vary from the programmed value due to the effects of load resistance. The *Output Selection* option provides a trimming feature you can use to compensate for any such variations. To accurately trim the outputs, you will need a digital multimeter capable of measuring 0 to 2 V with a resolution of  $\pm 0.0001$  VDC (0.1 mV) or 0 to 20 mA with a resolution of  $\pm 0.01$  mA, depending on your output settings. Most good quality 3 1/2-digit multi-meters are adequate for output trimming. Complete the following steps to trim output:

1. Make sure the *Output Mode* has been set for the desired output (**Current** or **Voltage**).
2. Temporarily disconnect the load from the output signal wires. Then, attach the digital multimeter to the signal wires either in *series* (for *Current* mode) or in *parallel* (for *Voltage* mode) with the load.
3. Tap the **Channel (1-6)** and **Output (A or B)** to be trimmed, and then tap the **Trim** button to open a screen similar to *Figure 45* below.



**Figure 45: Output Trim Screen**

4. Tap the **Reset Trim** button to clear the current trim values.
5. Tap the **Trim Zero** button to output the zero value, and enter the value shown on your multimeter in the **Trim Zero** text box.
6. Tap the **Trim Span** button to output the span value, and enter the value shown on your multimeter in the **Trim Span** text box.
7. Tap the **Exit** button and test the output as described in “*Testing the Selected Output*” on page 50.

**Note:** The 0% of full scale value is: 1 mA for a 0-20 mA scale, 4 mA for a 4-20 mA scale or 0.1 V for a 0-2 V scale.

#### 4.1.4 Setting the Output Range Error Response

A *Range Error* can occur when a measured value is within the capacity of the analyzer, but it exceeds the calibration range of the probe. They can be either **Under Range** or **Over Range** errors.

The moisture.IQ indicates *Range Errors* with an **Over Range** or **Under Range** message. The error condition applies to all measurements of the same mode. For example, if a dew point measurement is **Over Range**, then moisture in ppMv will also be **Over Range**. If multiple *Range Errors* occur simultaneously, the moisture.IQ responds to them in the following order: **Oxygen Errors**, **Moisture Errors**, **Temperature Errors** and then **Pressure Errors**.

Complete the following steps to configure the range error response of the selected output:

1. Tap the desired **Channel (1-6)** and **Output (A or B)**, and then tap the **Range Error** button to open a screen similar to *Figure 46* below.

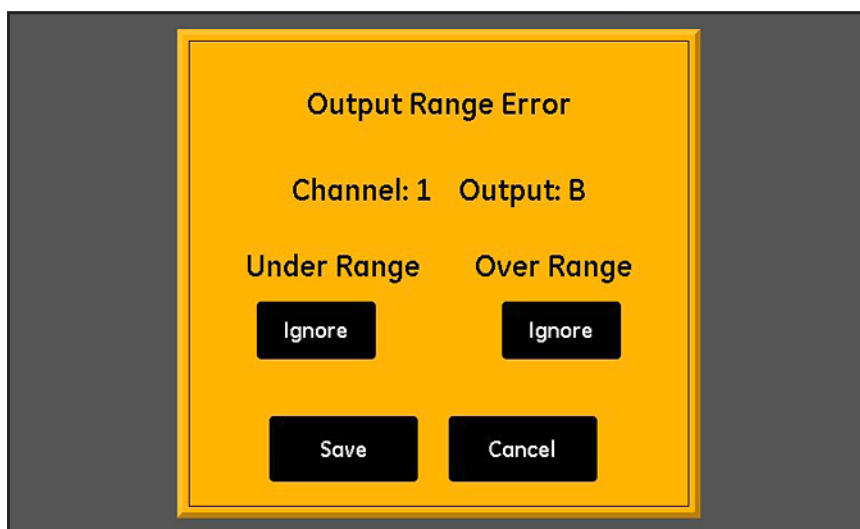

**Figure 46: Range Error Setup Screen - Output Response**

2. Set the output to be driven either **High** on Under Range errors, **Low** on Under Range errors or to **Ignore** Under Range errors (**Ignore** is the default setting).
3. Set the output to be driven either **High** on Over Range errors, **Low** on Over Range errors or to **Ignore** Over Range errors (**Ignore** is the default setting).
4. Tap the **Save** button to keep the new settings or tap the **Cancel** button to keep the previous settings.



## 4.2 Setting Up the Alarms

### 4.2.1 Configuring an Alarm

**Note:** An active alarm is indicated by a “Play” symbol, and the alarm selected for editing is highlighted in yellow.

The moisture.IQ features two optional alarms (A and B) for each of its six channels. To configure these alarms, refer to the menu map in *Figure 77 on page 110* and tap the **Alarms** button on the right side of the main touch screen to open a screen similar to that shown in *Figure 47* below.

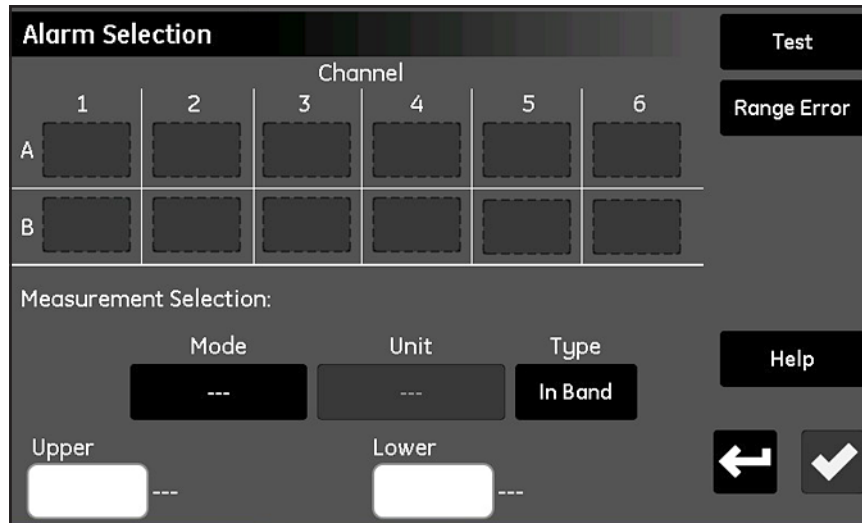

**Figure 47: Alarm Selection Screen**

1. Tap the button for the desired **Channel** (1-6) and **Alarm** (A or B).
2. In the *Measurement Selection* section, tap the **Mode**, **Unit** and **Type** (**In Band**, **Out Band** or **Setpoint**) buttons to enter the desired settings for the alarm. (For available modes and units, refer to *Table 8 on page 61*.)
3. Tap the *Upper* text box and enter the upper value via the keypad. Repeat this procedure for the *Lower* value.

## 4.2.2 Testing the Selected Alarm

Complete the following steps to test the alarm:

1. Tap the **Channel (1-6)** and **Alarm (A or B)** to be tested, and then tap the **Test** button to open a screen similar to *Figure 48* below.

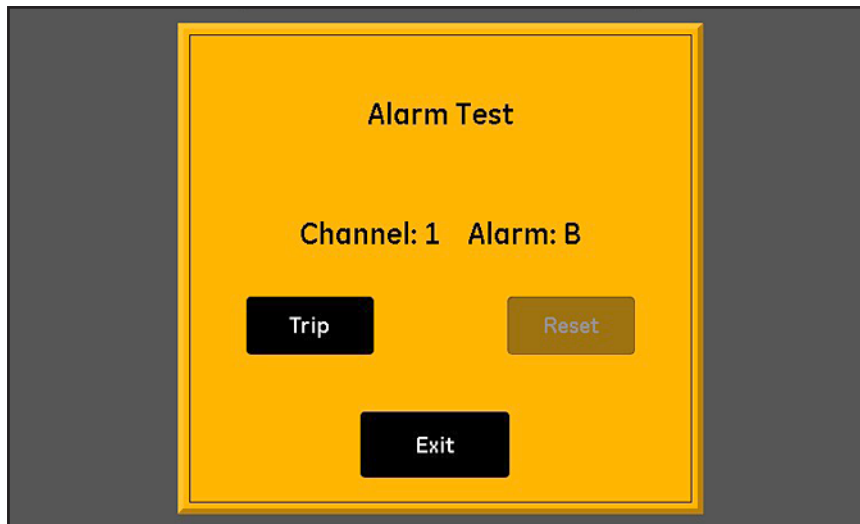

**Figure 48: Alarm Test Screen**

2. Tap the **Trip** button to trip the alarm and verify that the alarm has been tripped.
3. Tap the **Reset** button to reset the alarm and verify that the alarm has been reset.
4. After you have finished testing the alarm, tap the **Exit** button to return to the *Alarm Selection* screen.

### 4.2.3 Setting the Alarm Range Error Response

A *Range Error* can occur when a measured value is within the capacity of the analyzer, but it exceeds the calibration range of the probe. They can be either **Under Range** or **Over Range** errors.

The moisture.IQ indicates *Range Errors* with an **Over Range** or **Under Range** message. The error condition applies to all measurements of the same mode. For example, if a dew point measurement is **Over Range**, then moisture in ppmV will also be **Over Range**. If multiple *Range Errors* occur simultaneously, the moisture.IQ responds to them in the following order: **Oxygen Errors, Moisture Errors, Temperature Errors** and then **Pressure Errors**.

Complete the following steps to configure the range error response of the selected alarm:

1. Tap the **Channel (1-6)** and **Alarm (A or B)**, and then tap the **Range Error** button to open a screen similar to *Figure 49* below.

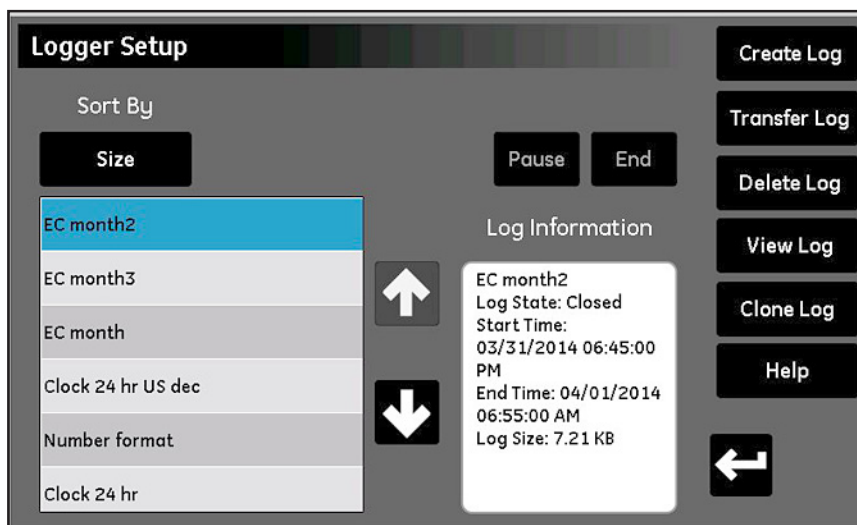

**Figure 49: Range Error Setup Screen - Alarm Response**

2. Set the alarm to either **Trip** on *Under Range* errors or to **Ignore** *Under Range* errors (**Ignore** is the default setting).
3. Set the alarm to either **Trip** on *Over Range* errors or to **Ignore** *Over Range* errors (**Ignore** is the default setting).
4. Tap the **Save** button to keep the new settings or tap the **Cancel** button to keep the previous settings.

### 4.3 Setting Up and Running Logs

To set up and run logs, refer to the menu map in *Figure 77 on page 110* and tap the **Logger** button on the main touch screen to open a screen similar to *Figure 50* below.



**Figure 50: Logger Setup Screen**

The following logging functions are available on the *Logger Setup* screen:

- The pane on the left lists all current log files in memory. Tap the **Sort By** button and then select **Name**, **Date**, **Size** or **Running** from the drop-down list to specify the manner in which the list of log files is sorted.
- To see more details about any of the listed log files, highlight the desired files and the available information for that log will be displayed in the **Log Information** pane.
- The two buttons above the *Log Information* pane are used to control a **Running** log. Tap the **End** button to permanently end the log or tap the **Pause** button to temporarily suspend the log. After a log is paused, that button changes to a **Start** button. Tap this button to resume a paused log or to start a new log.
- **The Transfer Log** button is used to move a highlighted log file from the internal moisture.IQ memory to a connected USB drive. Tap the **Transfer Log** button and follow the instructions.
- **The Delete Log** button is used to delete a highlighted log file. Tap the **Delete Log** button and then confirm your choice.
- **The View Log** button is used to view the measurements selected for a highlighted log file. Tap the **View Log** button, and the measurements are shown in the **Log Information** pane.
- **The Clone Log** button is used to create a new log based on the settings of a highlighted existing log. If a log has ended, you can create a new log with identical measurements and options. Tap the **Clone Log** button, edit the filename for the cloned log, and modify the **Start Time** and **End Time**. If desired, you may also modify the **Separator**, **Log Type** or **Measurements** settings. When the setup is complete, tap the **Return** button and start the new log.

### 4.3 Setting Up and Running Logs (cont.)

- **Create Log** button:
  - a. Tap the **Create Log** button to open the *Log Creator* screen, as shown in *Figure 51* below.

**Figure 51: Log Creator Screen**

- b. Enter the **Log File Name**, the **Start Time**, the **End Time**, the **Separator** (**Comma** or **Tab**), the **Log Type** (**Normal**, **Cyclic** or **Error**) and the **Logging Interval** (in **minutes:seconds**).
- c. Tap the **Log Data** button at the upper right corner of the **Log Creator** screen to open the **Log Data** screen.
- d. Highlight one of the 16 log measurement boxes and use the buttons at the top of the screen to specify the **Channel**, **Mode** and **Unit** for that measurement.
- e. After you have finished configuring your log data, tap the **Return** button to return to the *Log Creator* screen above. Then, tap the **Return** button again to return to the *Logger Setup* screen.
- f. When you are ready, tap the **Start** button to begin running the new log.

[no content intended for this page]

## Chapter 5. Using the Configuration Menu

### 5.1 Configuring the Probes

After establishing the meter settings, you must configure and calibrate the attached probes. Although the probes are physically connected to the back of the electronics unit, you must program the moisture.IQ with the type of measurements you need the probe to make. In addition, if you want to use a constant value rather than a live input, or if you want to apply a user function, you must program the moisture.IQ accordingly. If you do not activate the probes, or if you activate them incorrectly, the meter will display **No Probe** or other error messages.

Refer to the menu map in *Figure 78 on page 111* and tap the **Configuration** button on the main screen to open the *Configuration Menu* (see *Figure 52* below).

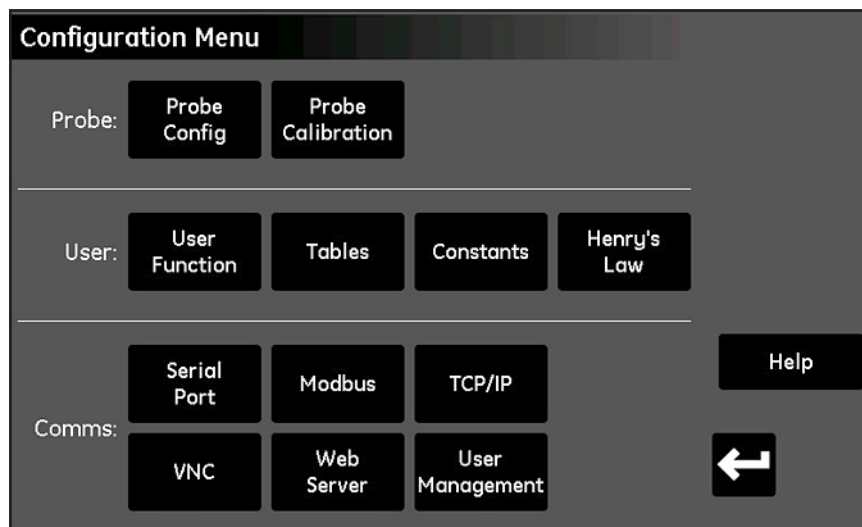
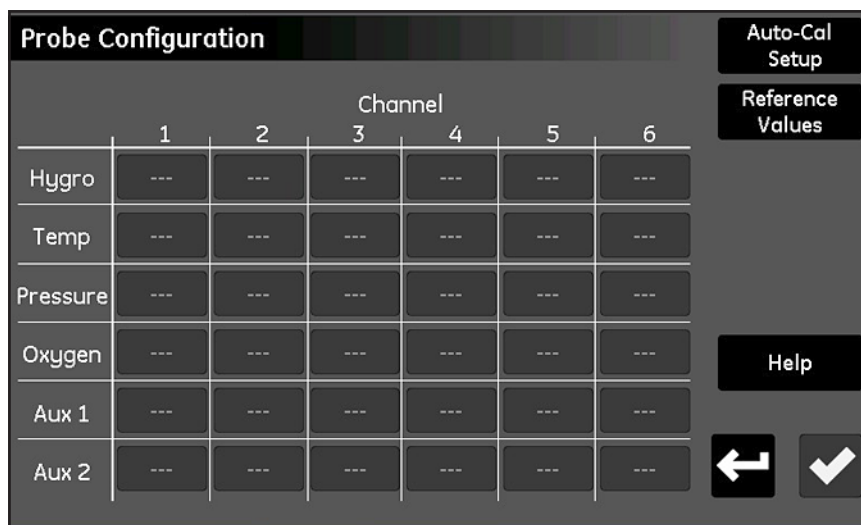

Figure 52: Configuration Menu Screen

### 5.1.1 The Probe Configuration Screen

Tap the **Probe Config** button to open the *Probe Configuration* screen (see Figure 53 below).



**Figure 53: Probe Configuration Screen**

From the *Channel vs. Mode* grid, you can activate the installed probes on each channel. See Table 8 on page 61 for the available measurement modes and units. The probe options vary with the *Mode* selected, as follows:

- **Hygro - M-Series**, MISP/MISP2 (**MIS**), Constant Value (**kH**) or M-Series with Computer-Enhanced Response\* (**M-CER**)

**Note:** Only M-Series PR probes will work with Computer-Enhanced Response. On the main display, the measurement label will appear in blue.

- **Temp - M-Series**, MISP/MISP2 (**MIS**), Constant Value (**kT**)
- **Pressure** - MISP/MISP2 (**MIS**), Auxiliary Input 1 (**Aux 1**), Auxiliary Input 2 (**Aux 2**) or Constant Value (**kP**)
- **Oxygen** - GE01-GE09, % O2 (**Percent**), PPM O2 (**Parts per Million**), PPB O2 (**Parts per Billion**) [see “Configuring Delta F Oxygen Sensor Probes” on page 63 for details.]
- **Aux 1** - mA (current), Volts (voltage)
- **Aux 2** - mA (current), Volts (voltage)

**IMPORTANT:** Activating probes that are not physically connected to the meter will result in error messages and slow performance.



### 5.1.1 The Probe Configuration Screen (cont.)

**Table 8: Available Measurement Modes and Units**

Selected Measurement Mode	Unit Description	Displayed Measurement Mode	Displayed Units
Oxygen	% = Percent Oxygen (default)	Oxygen	%
	PPM = Parts Per Million	Oxygen	PPM
	PPB = Parts Per Billion	Oxygen	PPB
	$\mu$ = Microamps (Diagnostic Mode)	Oxygen	$\mu$
Hygrometry	DP °C = Dew/Frost Point Degrees Celsius (default)	Dew Point	°C
	DP °F = Dew/Frost Point Temperature Fahrenheit	Dew Point	°F
	PPMv = Parts per Million of Water by Volume	H <sub>2</sub> O	PPMv
	PPBv = Parts per Billion of Water by Volume	H <sub>2</sub> O	PPBv
	PPMw = Parts per Million of Water by Weight	H <sub>2</sub> O	PPMw
	RH % = Relative Humidity	Rel. Humidity	%
	MMSCFig = Pounds of Water per Million Std. Cubic Feet in Ideal Gas	H <sub>2</sub> O/MMSCFig	Lbs
	MMSCFng = Pounds of Water per Million Std. Cubic Feet in Natural Gas	H <sub>2</sub> O/MMSCFng	Lbs
	Equiv DP°C NG = Equivalent Dew/Frost Point Degrees Celsius in Natural Gas	Equiv DP	°C
	Equiv DP°F NG = Equivalent Dew/Frost Point Degrees Fahrenheit in Natural Gas	Equiv DP	°F
	PPMv/ng = Parts Per Million by Volume in Natural Gas	H <sub>2</sub> O/Natural Gas	PPMv
	g/m <sup>3</sup> = grams per meter cubed	Hygro	g/m <sup>3</sup>
	mg/m <sup>3</sup> = milligrams per meter cubed	Hygro	mg/m <sup>3</sup>
	Pw/kPa = Vapor Pressure in KiloPascals	Vapor Pressure	kPa
	Pw/mmHg = Vapor Pressure in Mercury	Vapor Pressure	mmHg
	MH = MH* (Diagnostic Mode)	H <sub>2</sub> O	MH
FH = FH* (Diagnostic Mode)	H <sub>2</sub> O	FH	
Temperature	°C = Degrees Celsius (default)	Temperature	°C
	°F = Degrees Fahrenheit	Temperature	°F
	Kelvin = Kelvin	Temperature	K
	°R = Degrees Rankine	Temperature	°R

**Table 8: Available Measurement Modes and Units (cont.)**

<b>Selected Measurement Mode</b>	<b>Unit Description</b>	<b>Displayed Measurement Mode</b>	<b>Displayed Units</b>
Pressure	kPa(a) = KiloPascal Absolute (default)	Pressure	kPa(a)
	mPa(a)= MegaPascal Absolute	Pressure	MPa(a)
	Pa(a) = Pascal Absolute	Pressure	Pa(a)
	kPa(g) = KiloPascal Gauge	Pressure	kPa(g)
	mPa(g)= MegaPascal Gauge	Pressure	MPa(g)
	Pa(g) = Pascal Gauge	Pressure	Pa(g)
	PSI(a) = Pounds per Square Inch Absolute	Pressure	PSI(a)
	PSI(g) = Pounds per Square Inch Gauge	Pressure	PSI(g)
	ATM = atmospheres	Pressure	ATM
	Bar(a) = Bars Absolute	Pressure	Bar(a)
	Bar(g) = Bars Gauge	Pressure	Bar(g)
	mmHg = Millimeters of Mercury	Pressure	mmHg
	FP = FP* (Diagnostic Mode)	Pressure	FP
Auxiliary 1	mA = Milliamps (default)	Aux1	mA
	V = Volts	Aux1	V
	Scaled = scale defined by the user in the calibration menu	Aux1	Scaled
Auxiliary 2	mA = Milliamps (default)	Aux1	mA
	V = Volts	Aux1	V
	Scaled = scale defined by the user in the calibration menu	Aux1	Scaled
User	Func1-6 = User defined functions for each channel	TBD	TBD
*The MH, FH and FP values are the moisture sensors' response values and are the values that are recorded during calibration.			

### 5.1.2 Configuring Delta F Oxygen Sensor Probes

There are 13 selections available for the *Delta F Oxygen Sensor* probes. These are highlighted by the box in the *Probe Configuration* window shown in *Figure 54* below.

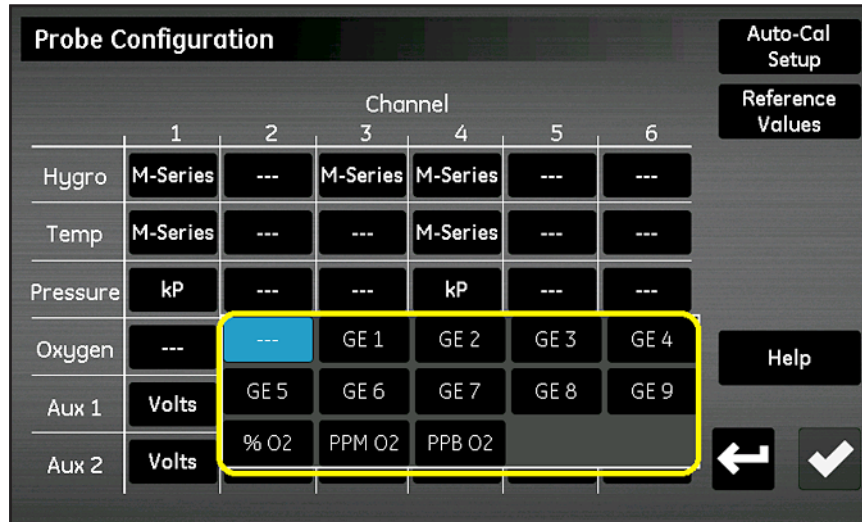
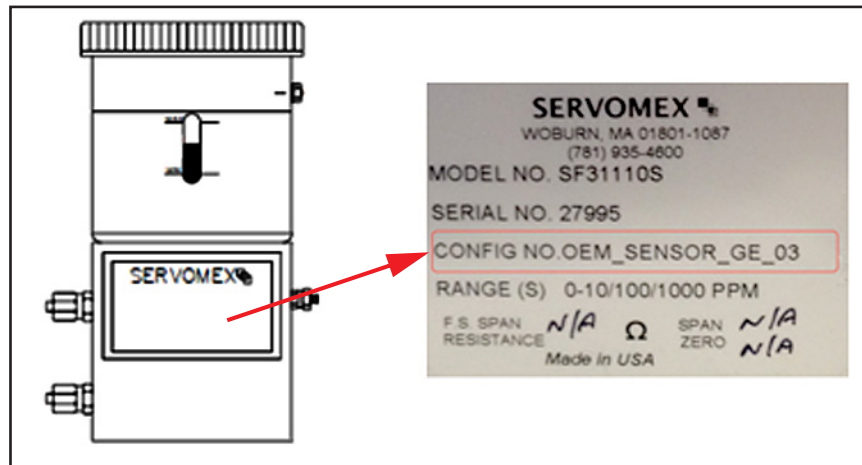

**Figure 54: Delta F Probe Configuration Screen**

The *Delta F Oxygen Sensor* probes are available in the two following types:

- **GE 1** through **GE 9**, which include temperature compensation
- **% O2**, **PPM O2** and **PPB O2**, which do not include temperature compensation

To properly configure your *Delta F Sensor* probe, use the information found on the label affixed to the sensor body. *Figure 55* below shows a sample label for a **GE3** sensor type.



**Figure 55: Sample Delta F Probe Label**

### 5.1.3 Calibrating Individual Channels

1. From the main screen, tap **Configuration**, then *Probe Config*, then *Reference Values* to access the Channel Calibration screen.

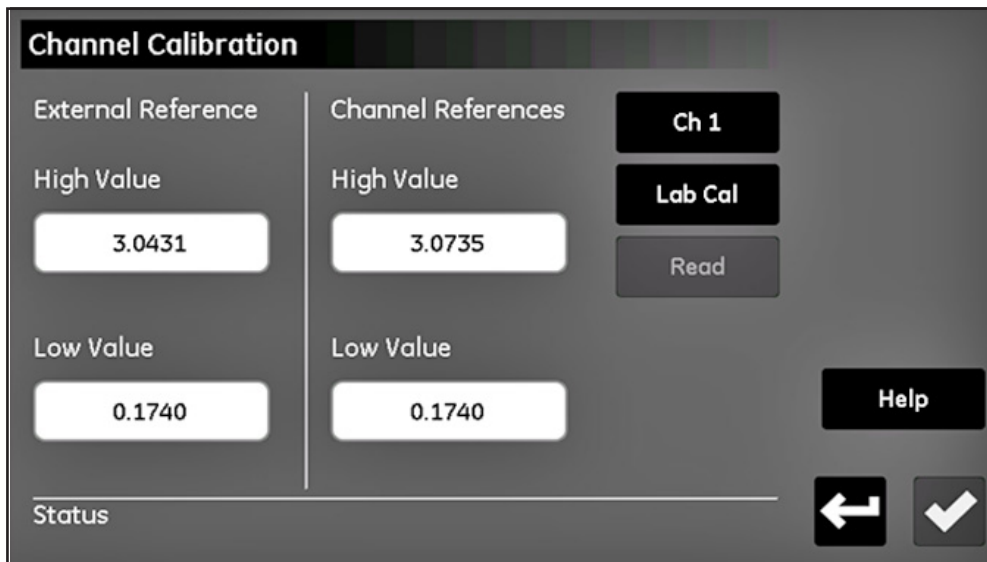

**Figure 56: Calibrating Channels**

2. In the Channel Calibration screen, enter the high and low values supplied with your dummy probes in their respective boxes under External References. Tap the **Check** button on the Channel Calibration screen after both values have been entered. Once this is completed, these values will be populated for every channel and do not need to be re-entered for subsequent calibrations.
3. Select the *Channel Number* for the desired channel to configure. Make sure this is the channel to which your calibration probes will be attached.
4. Tap the **Lab Cal** button to begin the low value calibration. The system will check for an active AutoCal before proceeding. The status should read “Connect probe to channel X, then click Read”. Connect your low value dummy probe to the M-Series input on the corresponding channel of the moisture.IQ module.
5. Tap the **Read** button. Wait up to a minute. When complete, the status will show “Reading complete on channel X\*.”
6. Disconnect the low value dummy probe and connect the high value dummy probe. *Do not* change the external reference values or tap the **Check** button.
7. Tap **Lab Cal** again, and wait for the message, “Connect the probe to channel X, then click Read.” Tap **Read** and wait 2-3 minutes.
8. When complete, the new High and Low values will appear in their respective boxes under Channel Calibration. You can now exit the Channel Calibration screen with the **Return** button, or repeat steps 3-8 for any other channel requiring calibration.

### 5.1.4 Setting the Probe Auto-Cal Schedule

To set the frequency with which the probe *Auto-Cal* function is run, proceed as follows:

1. From the *Probe Configuration* screen, tap **Auto-Cal Setup** button to access the *Set Auto-Cal Interval* screen for the desired probe (see *Figure 57* below).

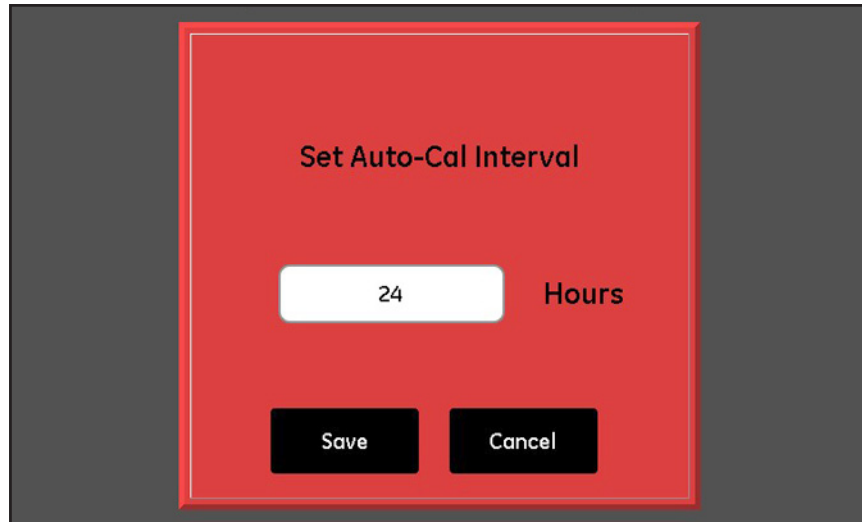

**Figure 57: Set Auto-Cal Interval Screen**

2. Enter the desired number of hours (1 - 730) between *Auto-Cal* runs.
3. Tap the **Save button** to enter the new value into the moisture.IQ, or tap the **Cancel** button to retain the previous value.

## 5.2 Calibrating the Probes

For newly-purchased moisture.IQ systems, GE has already entered the required calibration data for all purchased moisture and oxygen sensors. However, you should verify this data before startup. You will also need to enter new calibration data if you *install a probe from your stock or attach a transmitter to the auxiliary inputs*.

**Note:** *For hygrometry, you need to enter calibration data only for M Series probes. It is not necessary to enter calibration data for the Moisture Image Series Probe unless you send the probe back to GE for calibration without its electronics module. If this is the case, enter the calibration data for the re-calibrated probe as described in this section. The moisture.IQ will automatically download the new calibration data into the Moisture Image Series Probe electronics module.*

### 5.2.1 Entering Calibration Data Automatically

For moisture and oxygen probes included with the analyzer, GE pre-installs the corresponding calibration data files. To enter this calibration data, proceed as follows:

1. On the *Probe Calibration* screen, select the *Channel Number* where a probe requiring calibration is attached. Then, tap the **FIND** button to display a list of all included probes by serial number.
2. Scroll the list to find and select the data file matching the probe to be calibrated, and tap the **Save** button. The calibration data for that probe will be automatically entered into the calibration table.
3. Tap the **Check** button to use the new data.

### 5.2.2 Entering Calibration Data Manually

Be sure you have the **Calibration Data Sheets** that are supplied with each GE probe. Each *Calibration Data Sheet* consists of a list of data points that must be entered or verified. Each *Calibration Data Sheet* lists the corresponding probe *serial number*, as well as the preassigned *channel number*. *Calibration Data Sheets* are usually packed inside the case of the corresponding probe.

To enter your calibration data, refer to the menu map in *Figure 78 on page 111* and complete the following steps:

1. From the *Configuration Menu*, tap the **Probe Calibration** button to open a *Probe Calibration* screen similar to *Figure 58 on page 67*. **Note that the serial number of the corresponding probe is listed at the top of the screen for reference.**

## 5.2.2 Entering Calibration Data Manually (cont.)

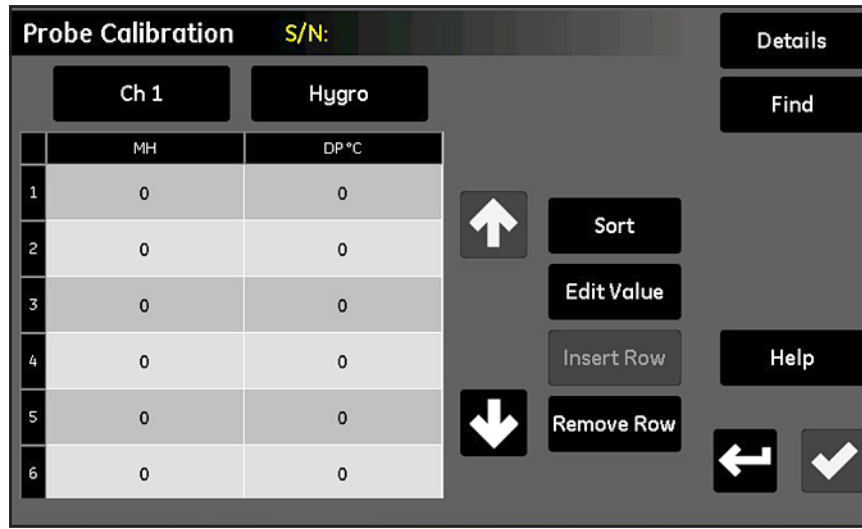

Figure 58: Probe Calibration Screen

2. Just below the probe serial number, tap the **Channel** button to select the channel to which the probe is connected.
3. To the right of the **Channel** button, tap the **Type** button to select the type of input connected to that channel (**Hygro, Pressure, Oxygen, Aux 1** or **Aux 2**).
4. For each input selected, the table below the two buttons includes data entry boxes for 2 to 16 data points. The four buttons to the right of the table are used to edit and arrange the calibration data as required:
  - **Sort** - Tap this button to sort the data rows in ascending order by the left column.
  - **Edit Value** - Tap this button and then tap a text box and enter the values from the relevant *Calibration Data Sheet* for each point specified, using the calculator keys on the pop-up keypad. Continue entering or checking values for each input until you have completed each channel.
  - **Insert Row** - Use this button along with the **Remove Row** button to organize the rows in the table as desired.
  - **Remove Row** - Use this button along with the **Insert Row** button to organize the rows in the table as desired.
5. After you have finished entering your probe calibration data, tap the **Return** button to return to the *Configuration Menu*.

### 5.3 Tagging the Inputs

The moisture.IQ enables users to assign tags to customize the display of the input parameters. The instrument accepts a separate 9-character label for each input. To tag inputs, complete the following steps:

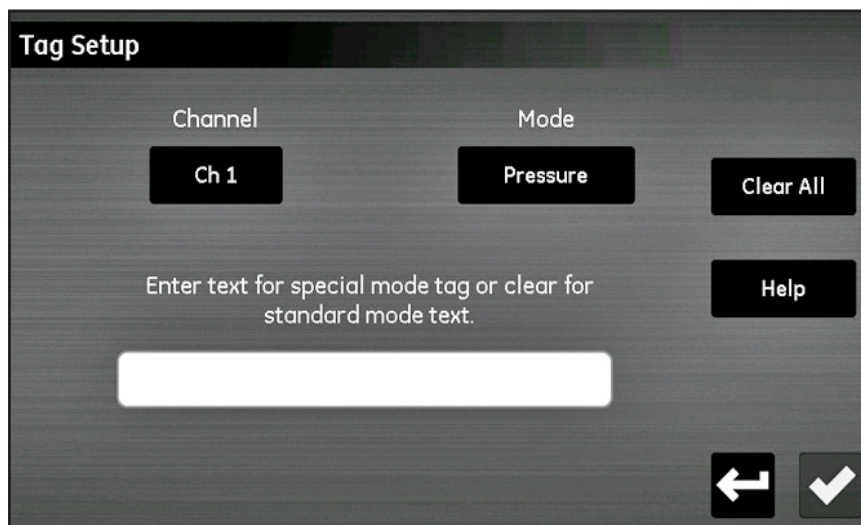

Figure 59: Tag Setup

1. From the *Configuration Menu* screen, tap the **Tagging** button to open the Tag Setup screen.
2. Tap the **Channel** button and specify the channel for which the **Tag** should be applied.
3. Tap the **Mode** button and select either **Hygro**, **Pressure**, **Temperature**, **Oxygen**, **Aux 1** or **Aux 2** from the drop-down list.
4. Tap the text bar to enter the tag for the selected **Channel and Mode**. Tap the **Save** button after entering the text, then tap **Save** to complete the process.

**Note:** To remove a tag, tap **Clear All**, then tap **Save**.



## 5.4 Entering User Information

Refer to the menu map in *Figure 78 on page 111* and to *Figure 52 on page 59* (the *Configuration Menu* screen) to enter the following types of user information:

- **User Functions** (see “*Entering User Functions*” on page 69)
- **User Tables** (see “*Entering User-Defined Tables*” on page 71)
- **User Constants** (see “*Entering User Constants*” on page 72)
- **Saturation Constants** (see “*Entering Saturation Constants*” on page 73)

### 5.4.1 Entering User Functions

*User Functions* permit the programming up to four mathematical equations on each channel. Any parameter on any channel can be used to calculate a different parameter. To enter a new user function or to edit an existing function, complete the following steps:

1. Tap the **User Function** button on the *Configuration Menu* screen (see *Figure 52 on page 59*) to open the *User Function Setup* screen (see *Figure 60* below).

**Figure 60: User Function Setup Screen**

2. Tap the **Channel** button to select the channel where the function will be applied.

### 5.4.1 Entering User Functions (cont.)

3. Tap the **User Function** button to select the function name (**Func 1**, **Func 2**, **Func 3** or **Func 4**). Then, tap the large text box just below the **Channel** button to open the *Channel x:User Function y* screen, as shown in *Figure 61* below, to enter the function equation. When the equation is complete, tap the **Check** button to return to the *User Function Setup* screen.

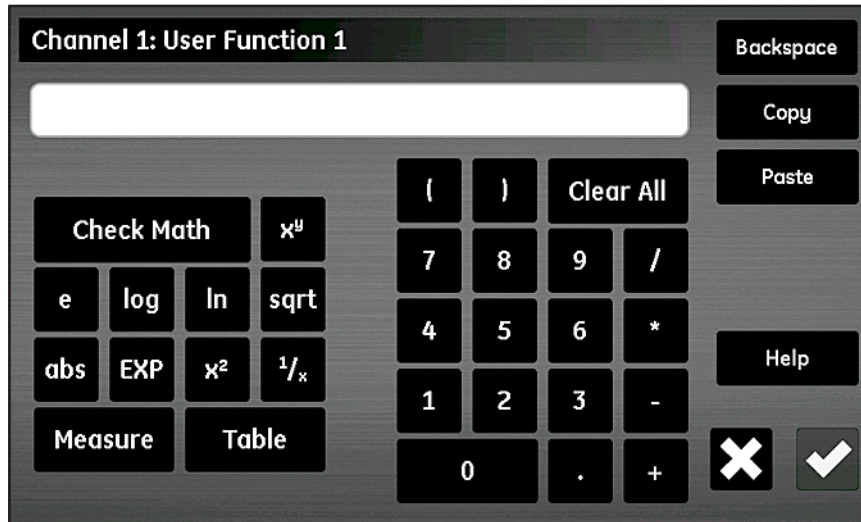

**Figure 61: User Function Equation Screen**

The buttons in *Figure 61* above permit the inclusion of standard mathematical functions, lookup data from predefined user tables (see “*Entering User-Defined Tables*” on page 71). The **Check Math** button is used to find any errors in the equation definition. Also, you may tap the **Clear All** button at any time to start over. The **Copy** and **Paste** buttons at the top right corner of the screen may be used to duplicate information from one user function to another to avoid entering the same information multiple times.

**Note:** To assist in entering the user function, the current definition is shown at the bottom center of the User Function Setup screen as the following selections are made.

4. Tap the **Function Label** text box to open the **Edit Function Label** screen and use the keyboard to enter the desired label.
5. Tap the **Unit text box** to open the **Edit Unit Label** screen and use the keyboard to enter the desired units.
6. Tap the **Decimals** text box and enter the desired number of decimal places for the function (1 - 6).
7. Tap the **Max** and **Min** text boxes to enter the **Valid Range** for the function in digits from the keypad.
8. After the functions has been defined, tap the **Return** button to return to the *Configuration Menu*.

## 5.4.2 Entering User-Defined Tables

To support user-defined functions, the moisture.IQ allows up to six user-defined tables (designated as **Table A** through **Table F**) of non-linear or empirical data. Up to 10 **X-Y** pairs can be entered in each table. If a user function inputs an **X** value, the meter interpolates the corresponding **Y** value and outputs that value to the function. (The results are extrapolated if the **X** value exceeds the range of the table.)

From the *Configuration Menu* screen (see *Figure 52* on page 59), tap the **Tables** button to open a *User Table Setup* screen similar to *Figure 62* below.

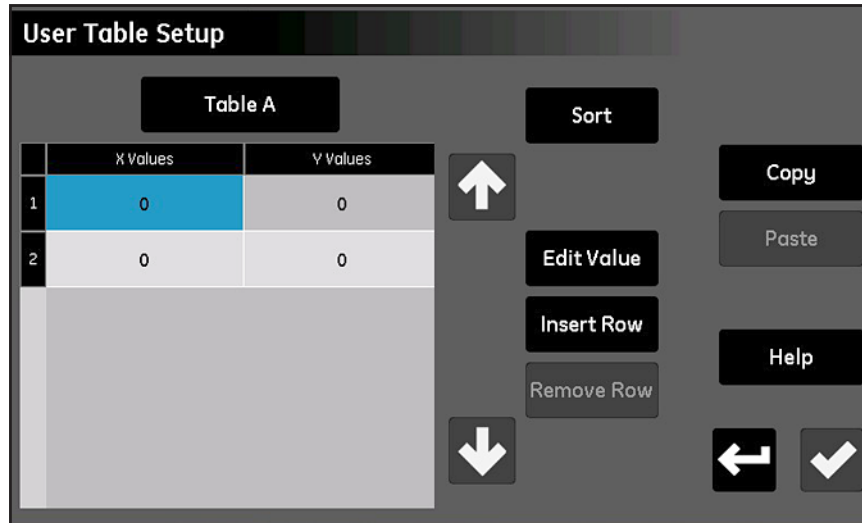

**Figure 62: User Table Setup Screen**

To set up a user table, complete the following steps:

1. Tap the button at the upper left of the screen to select the *table name* (**Table A** through **Table F**) from the drop-down list.
2. The table may contain from 2-10 rows. Use the **Insert Row** and **Delete Row** buttons to configure the table with the desired number of rows.
3. To enter or edit the data in the table, tap the desired table cell to highlight it in blue. Then, tap the **Edit Value** button to enter the data for that cell. Repeat this process until all of the data has been entered.

**Note:** The **Copy** and **Paste** buttons can be used to copy data from another table into this new table.

4. After all of the data has been entered, tap the **Sort** button to be sure the data points are arranged in ascending order of **X** values. Then, tap the **Check** button to save the table and tap the **Return** button to return to the *Configuration Menu*.

### 5.4.3 Entering User Constants

User-defined constants can be substituted for *Dewpoint* (°C), *Temperature* (°C) and *Pressure* (Pa) measurements in all meter calculations. In addition, you can multiply all measured moisture PPMv values by a specified constant (the default multiplier is 1.000).

From the *Configuration Menu* screen (see *Figure 52* on page 59), tap the **Constants** button to open a *User Constant Setup* screen similar to *Figure 63* below.

**Figure 63: User Constant Setup Screen**

To enter user constants, complete the following steps:

1. Tap the **Channel** button to select the channel for which the constant should be applied.
2. Tap the text box for the **Hygro**, **Temperature** and/or **Pressure** values and enter the desired constant for each measurement type. The specified values will then be used as a constant multiplier for that measurement type in all future meter calculations.

**IMPORTANT:** Before the moisture.IQ can use the constants entered above, the probe type on the specified channel must be properly configured for **Constant Value (kH, kT or kP)**, as described in “The Probe Configuration Screen” on page 60.

3. If desired, tap the **k x ppmv** text box to enter a constant multiplier for all PPMv moisture measurements. Note that no special probe configuration setting is required for the constant multiplier to be used.
4. If you are using a *Delta F Oxygen Cell* probe and your background gas is not *Nitrogen*, you must apply a correction factor to all measurements (see “*Delta F Oxygen Cell Background Gas Correction Factors*” on page 91). To do so, tap the **O2 Background Correction** text box and change the multiplier from the default value of 1.00 to the required value.
5. After all constants have been entered, tap the **Return** button to return to the *Configuration Menu* screen.

### 5.4.4 Entering Saturation Constants

Henry's Law is applicable to ppmw moisture measurements in all organic liquids. It states that, "At a constant temperature, the amount of a given gas that dissolves in a given type and volume of liquid is directly proportional to the partial pressure of that gas in equilibrium with that liquid." In other words,  $PPMw = (Pw/Ps) \times Cs$ . To calculate ppmw moisture values for an organic liquid with the moisture.IQ, saturation values (**Cs**), as a function of temperature, must be entered in the *Cs Table* shown in Figure 64 below.

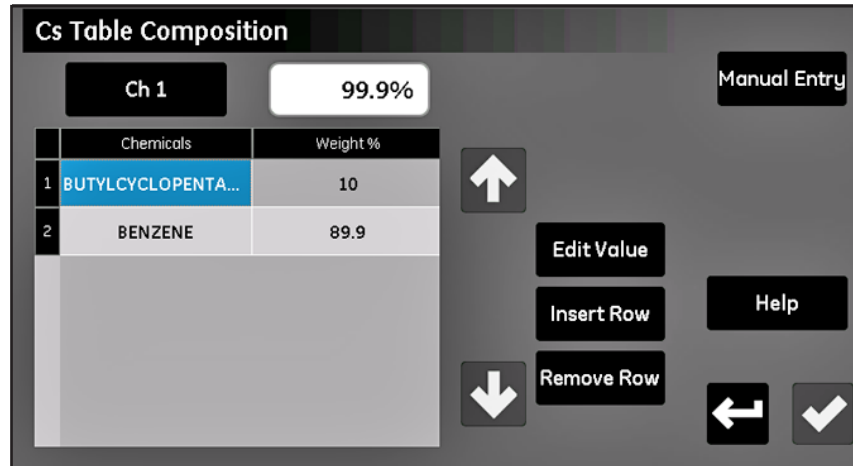

Figure 64: Cs Table (Henry's Law) Screen

To enter the Cs values for your application, complete the following steps:

1. Tap the **Channel** button and specify the channel for which the Cs curve should be applied.
2. Use the **Insert Row** and **Remove Row** buttons to configure the table with up to 10 rows.
3. To enter or edit the data in the table, tap the desired table cell to highlight it in blue. Then, tap the **Edit Value** button to enter the data for that cell.



Figure 65: Selecting the Chemical

### 5.4.4 Entering Saturation Constants (cont.)

4. Select the **Chemical** and enter its percentage of the overall composition.
5. Repeat steps 2-4 until all of the data has been entered. After you select **Save**, the Cs Table will appear.

**Note:** *At least 90% of the total composition must be entered. For any compositions that total less than 100%, each chemical will be extrapolated to bring the total to 100%.*

#### 5.4.4.1 Entering Saturation Constants Manually

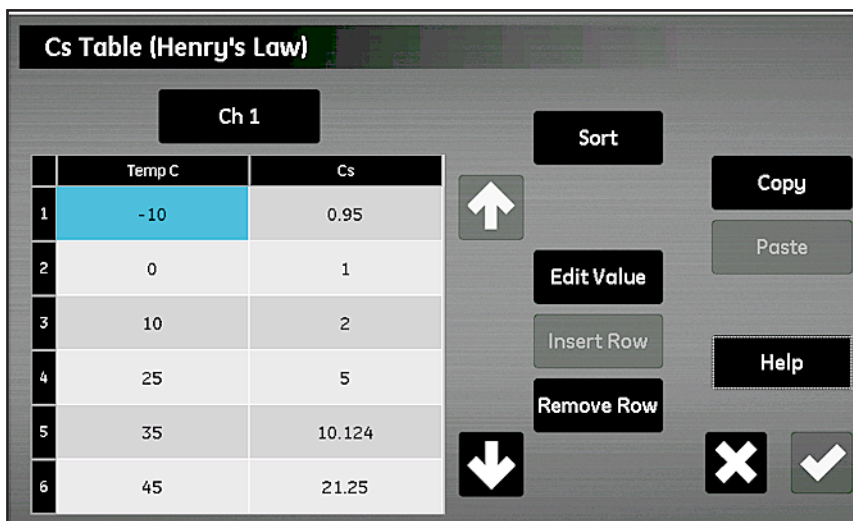

**Figure 66: Entering Constants Manually**

To manually enter the Cs values for your application, complete the following steps:

1. Select **Manual Entry**.
2. Tap the **Channel** button and specify the channel for which the Cs curve should be applied.
3. Use the **Insert Row** and **Remove Row** buttons to configure the table with up to 10 rows.
4. To enter or edit the data in the table, tap the desired table cell to highlight it in blue. Then, tap the **Edit Value** button to enter the data for that cell. Repeat this process until all of the data has been entered.

**Note:** *The **Copy** and **Paste** buttons can be used to copy data from another table into this new table.*

5. After all of the data has been entered, tap the **Sort** button to be sure the data points are arranged in ascending order of Temp C values. Then, tap the **Check** button to save the table and tap the **Return** button to return to the Configuration Menu.

## Chapter 6. Setting Up Communications

### 6.1 Setting Up moisture.IQ Communications

The **Comms** section of the *Configuration Menu* is used to set up all communications for the moisture.IQ (see *Figure 79 on page 112*). It includes the following options:

- Serial Port (see “*Configuring the Serial Port*” below)
- Modbus (see “*Configuring the Modbus Connection*” on page 76)
- TCP/IP (see “*Connecting to an Ethernet LAN*” on page 77)
- VNC (see “*Configuring a VNC Connection*” on page 82)
- Web Server (see “*Configuring the Web Server*” on page 83)
- User Management (see “*User Management Operations*” on page 84)

### 6.2 Configuring the Serial Port

**IMPORTANT:** For proper communications, the serial port settings for the moisture.IQ must be the same as those for the device connected to the moisture.IQ serial port.

To configure the moisture.IQ serial port, complete the following steps:

1. From the *Configuration Menu* screen (see *Figure 52 on page 59*), tap the **Serial Port** button to open a *Serial Port Setup* screen similar to *Figure 67* below.

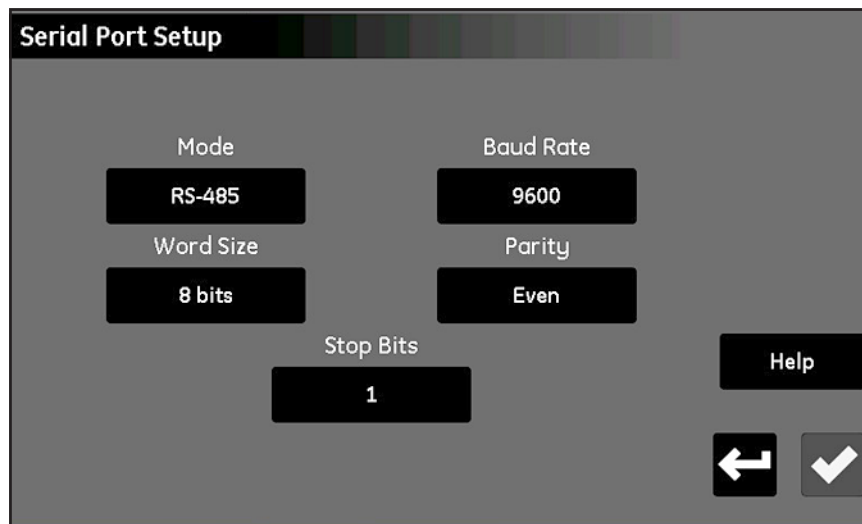

**Figure 67: Serial Port Setup Screen**

2. Tap the **Mode** button and select either **RS-232** or **RS-485** from the drop-down list.
3. Tap the **Baud Rate** button and select either **9600**, **19200**, **38400**, **57600** or **115200** from the drop-down list.

## 6.2 Configuring the Serial Port (cont.)

4. Tap the **Word Size** button and select either **7 bits** or **8 bits** from the drop-down list.
5. Tap the **Parity** button and select either **Even**, **Odd** or **None** from the drop-down list.
6. Tap the **Stop Bits** button and select either **1** or **2** from the drop-down list.
7. After all of the settings have been configured, tap the **Check** button to save your settings and then tap the **Return** button to return to the *Configuration Menu*.

**Note:** For RS-485 wiring, refer to Figure 83 on page 116.

## 6.3 Configuring the Modbus Connection

To configure the moisture.IQ *Modbus* connection, complete the following steps:

1. From the *Configuration Menu* screen (see Figure 52 on page 59), tap the **Modbus** button to open a *Modbus Setup* screen similar to Figure 68 below.

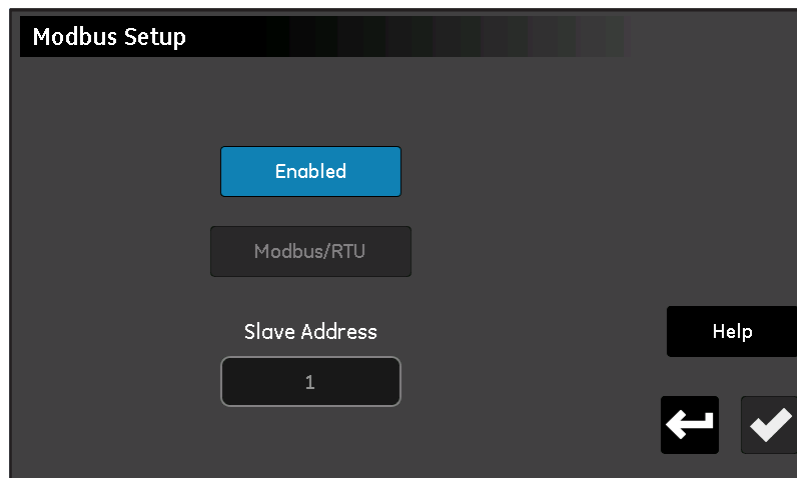

**Figure 68: Modbus Setup Screen**

2. If the **Enabled/Disabled** button indicates that the Modbus connection is currently Enabled, tap this button to Disable the Modbus connection (changes to the settings can only be made when the connection is Disabled).
3. Tap the second button to choose **Modbus/RTU** or **Modbus/TCP**.
4. For RTU, tap the **Slave Address** button and use the keypad to enter an address from 1 to 247 (the default setting is 1). For TCP, tap the **Port** button and use the keypad to enter a port from 81 to 65535 (the default setting is 502).
5. Tap the **Disabled** button to Enable the Modbus connection.
6. After the Modbus connection has been configured, tap the **Check** button to save your settings. Then, tap the **Return** button to return to the Configuration Menu.

**Note:** For a complete Modbus register map, see Table 13 on page 127.



## 6.4 Connecting to an Ethernet LAN

The moisture.IQ Ethernet port supports the **10Base-T** and **100Base-TX** twisted-pair Ethernet standards. An **RJ-45** female modular connector is provided on the moisture.IQ rear panel for connection to the **LAN**.



**WARNING!** The Ethernet capability provided in the moisture.IQ is designed for use on a limited-access Local Area Network (LAN) protected by a suitable firewall. It should not be operated if exposed to the Internet or other unmanaged Wide Area Network (WAN). Check with your network administrator to determine whether it is safe to connect the moisture.IQ to your network infrastructure.



**WARNING!** As shipped from the factory, there are two accounts enabled, with default passwords assigned. It is highly recommended that the default passwords be changed before placing the moisture.IQ into service.

**Note:** This chapter assumes that you have read Chapters 1 and 2, and are familiar with the operation and installation of the moisture.IQ electronics and user interface.

**Note:** Contact your network administrator to obtain the proper information to use in the following section.

### 6.4.1 Configuring the Ethernet TCP/IP Connection

The moisture.IQ can either be configured with a *static Internet Protocol (IP) address* or it can use the *Dynamic Host Configuration Protocol (DHCP)* to obtain an address from a **DHCP** server or router. No further address configuration is required. To configure the moisture.IQ **TCP/IP** connection, complete the following steps:

1. From the *Configuration Menu* screen (see *Figure 52 on page 59*), tap the **TCP/IP** button to open a *TCP/IP Setup* screen similar to *Figure 69* below.

Field	Value
LAN Access	Enabled
MAC Address	c4:b5:12:47:00:35
IP Address	Automatic (3.68.137.51)
Subnet	255.255.252.0
Gateway	3.68.136.1
DNS	Automatic (3.68.136.19)
Alternate DNS	3.40.208.20

**Figure 69: TCP/IP Setup Screen**

### 6.4.1 Configuring the Ethernet TCP/IP Connection (cont.)

2. If the **LAN Access** button indicates that the TCP/IP connection is currently **Enabled**, tap this button to **Disable** the TCP/IP connection (changes to the settings can only be made when the connection is **Disabled**). Note that the moisture.IQ **MAC Address** is shown as a read-only value.
3. Tap the **IP Address** button and select either **Automatic** or **Static** from the drop-down list. If **Static** is selected, enter values for the **IP Address** in dotted decimal notation (e.g., 192.168.1.123), the **Subnet** mask and the **Gateway** address in the text boxes provided.
4. Tap the **DNS** button and select either **Automatic** or **Static** from the drop-down list. If **Static** is selected, enter values for the **DNS** and **Alternate DNS** in the text boxes provided.

**Note:** *For troubleshooting purposes, automatically assigned addresses are visible on this screen.*

5. After the TCP/IP connection has been configured, tap the **Check** button to save your settings. Then, tap the **Return** button to return to the *Configuration Menu*.

### 6.4.2 Capabilities of the Ethernet Connection

**IMPORTANT:** *The Web Server opens **Port 80** when it is Enabled.*

**IMPORTANT:** *The VNC<sup>1</sup> connection opens **port 5900** (user-configurable) when **Enabled**.*

The moisture.IQ allows two methods of remote access and control:

- An embedded *Web Server* allows access to the moisture.IQ status and files using a standard web browser.
- A *Virtual Network Computing (VNC)* server allows full remote control of the moisture.IQ using any of several VNC clients.

**Note:** *Both the Web Server and the VNC Server are disabled by default.*

Access to the web server requires a *user name* and *password*. The moisture.IQ provides two accounts for configuration and general administration. Up to three additional accounts can be created for use as needed. Each account has a set of permissions that can be configured to limit network access to moisture.IQ features. The two pre-defined accounts are:

- **Admin**
- **Operator**

**1 VNC®** is a registered trademark of **RealVNC Ltd**

### 6.4.2.1 The Admin Account

The **Admin** account allows complete configuration of the Ethernet option. This account should be used only by experienced network administrators. Misuse of the **Admin** account could prevent connection to the moisture.IQ, enable unauthorized access to the moisture.IQ or possibly expose the network to unauthorized users.

The default login credentials for the **Admin** account are:

- *User name:* Admin
- *Password:* password

**IMPORTANT:** *It is IMPERATIVE that the Admin password be changed as soon as possible!*

Only the **Admin** can add, modify, or remove the other user accounts. To log in as the **Admin**, select **Configuration > User Management**. to open a *Log In* screen similar to *Figure 70* below.

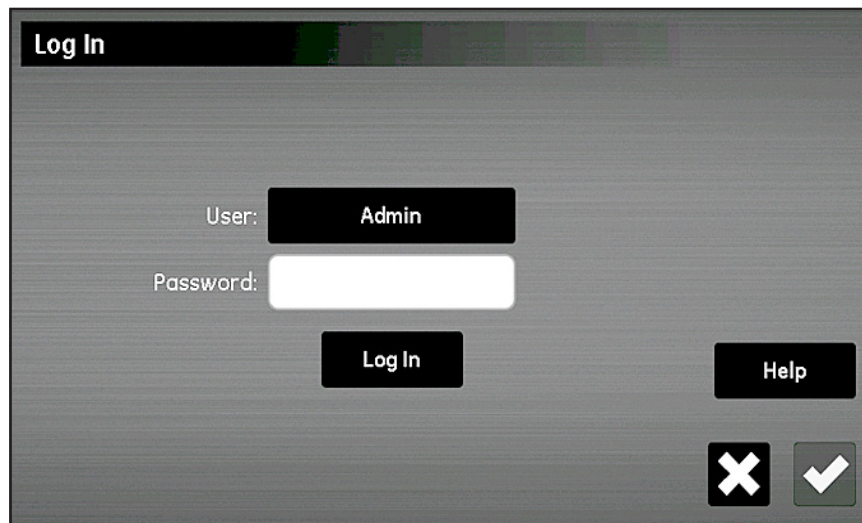

**Figure 70: Log In Screen**

### 6.4.2.1 The Admin Account (cont.)

Enter your password and tap the **Log In** button. On a successful login, the *Web User Management* screen shown in *Figure 71* below is opened.

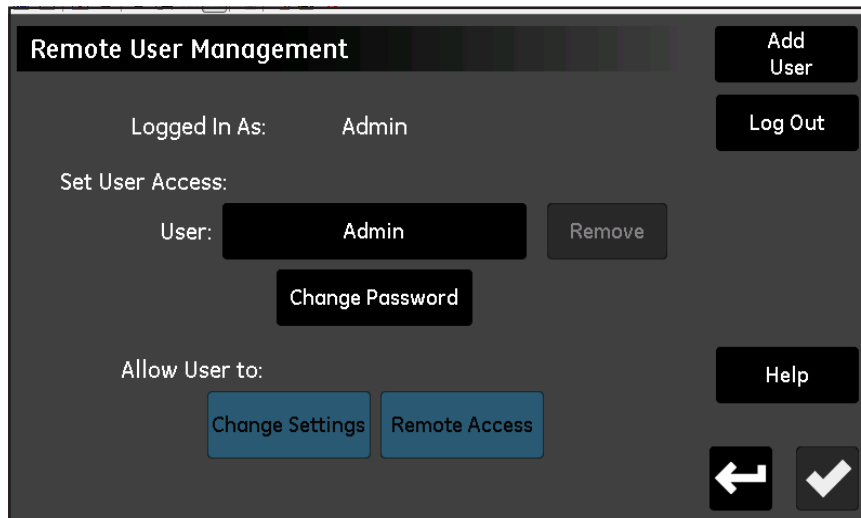

**Figure 71: Web User Management Screen**

Tap the **Change Password** button to enter and confirm a new password for the **Admin** account:



**CAUTION!** Record the new **Admin** password immediately and keep it in a safe and secure location. It is NOT POSSIBLE to obtain a lost or forgotten **Admin** password!

### 6.4.2.2 The Operator Account

The **Operator** account is provided to for day-to-day management of the moisture.IQ. By default, the **Operator** has all the same privileges as the **Admin**, but cannot create or modify other accounts. The **Operator** account allows the user to:

- Enable/Disable DHCP
- Specify a static IP, subnet, and gateway IP address
- Modify some of the serial protocol settings
- View the serial port connection status
- View the TCP/IP connection status
- View the Ethernet option firmware version, serial port and network diagnostics.

The default login credentials for the **Operator** account are:

- *User name:* Operator
- *Password:* password

The **Operator** password should be changed at the earliest opportunity. The steps for changing the **Operator** password are the same as for changing the **Admin** password (see previous section). Select the **Operator** account from the *Web User Management* screen (see *Figure 71 on page 80*), then enter and confirm the new password.

Record the new operator password immediately, and keep it in a safe and secure location.

**Note:** *If the operator password is lost, it can be reset using the **Admin** account.*

## 6.5 Configuring a VNC Connection

**IMPORTANT:** The VNC<sup>1</sup> connection opens **port 5900** (user-configurable) when **Enabled**.

**Note:** The moisture.IQ system cycle time may be increased by **VNC** usage.

A *Virtual Network Console (VNC)* connection allows remote access to the moisture.IQ by replicating the touchscreen on a PC monitor, tablet or smart phone. To configure a **VNC** connection, complete the following steps:

1. From the *Configuration Menu* screen (see *Figure 52* on page 59), tap the **VNC** button to open a *VNC Setup* screen similar to *Figure 72* below.

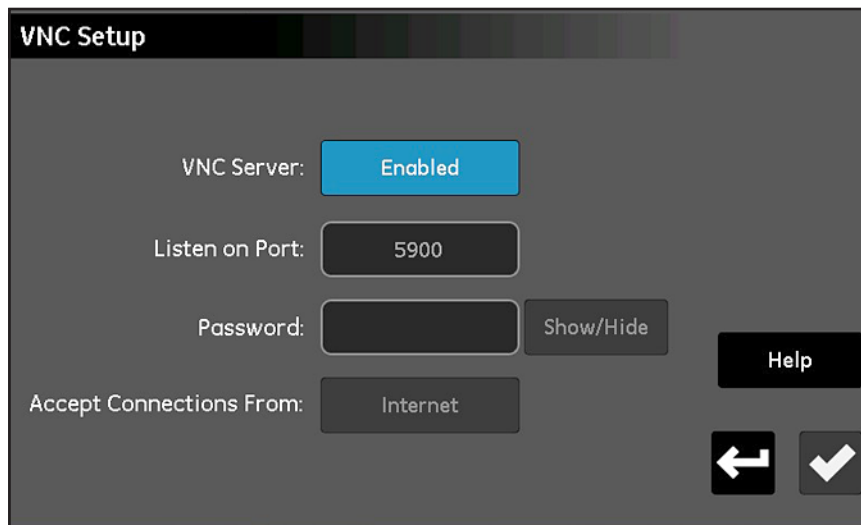

**Figure 72: VNC Setup Screen**

2. If the **VNC Server** button indicates that the **VNC Server** is currently **Enabled**, tap this button to **Disable** the **VNC Server** (changes to the settings can only be made when the **VNC Server** is **Disabled**).
3. Tap the **Listen on Port** button and enter the appropriate *Port Number*. Then, tap the **Check** button to save the value and tap the **Return** button to return to the *VNC Setup* screen. In most cases, the default **Port 5900** should be used.

**Note:** The **Password** and **Accept Connections From** buttons are not functional in this software version.

When a **VNC** client connection is established, the analyzer will display a *Log In* prompt. Log in using the credentials for the **Admin**, **Operator** or additional account that is configured to permit **VNC** connections. After a **VNC** connection has been established, the analyzer will display a “flashing eye” cursor  that tracks the remote user’s actions. This indicates to a local user that a remote user is connected. When the remote user disconnects, the “flashing eye” cursor is removed.

**1 VNC®** is a registered trademark of **RealVNC Ltd**

## 6.6 Configuring the Web Server

**IMPORTANT:** *The Web Server opens **Port 80** when it is **Enabled**.*

The moisture.IQ can be remotely accessed using a web browser by enabling the *Web Server*. To configure the **Web Server**, complete the following steps:

1. From the *Configuration Menu* screen (see *Figure 52 on page 59*), tap the **Web Server** button to open a *Web Server Setup* screen similar to *Figure 73* below.

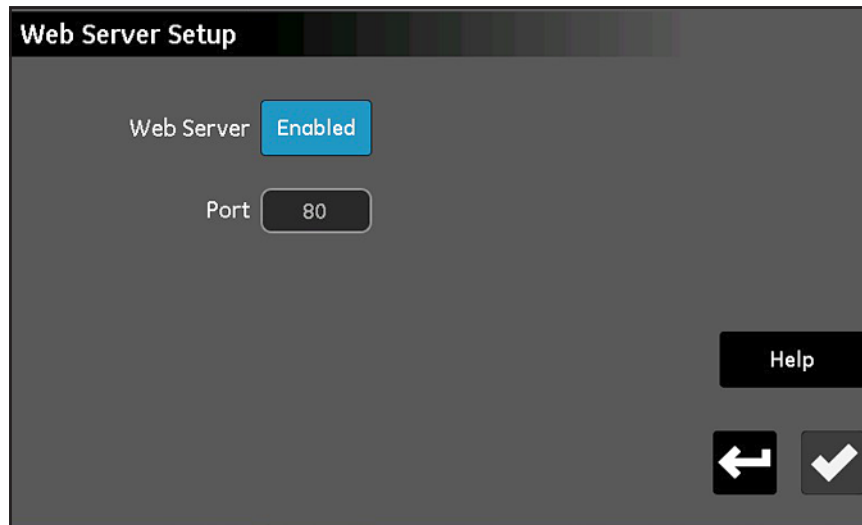

**Figure 73: Web Server Setup Screen**

2. If the **Web Server** button indicates that the *Web Server* is currently **Enabled**, tap this button to **Disable** the *Web Server* (changes to the settings can only be made when the **Web Server** is **Disabled**).
3. Tap the **Port** button and enter the appropriate *Port Number*. Then, tap the **Check** button to save the value and tap the **Return** button to return to the *Web Server Setup* screen. In most cases, the default **Port 80** should be used.
4. Tap the **Web Server** button so that it indicates that the server is either **Enabled** or **Disabled**, as desired.
5. After the *Web Server* status has been configured as desired, tap the **Return** button to return to the *Configuration Menu*.

When the *Web Server* is **Enabled**, it can be used to monitor the instrument status and to perform file downloads.

## 6.7 User Management Operations

The **User Management** option allows you to set up and control access to the moisture.IQ for *Web Server* and *VNC* users (see previous sections). Tap the button for the designated communication option to enter parameters. **to use this option, proceed as follows:**

1. From the *Configuration Menu* screen (see *Figure 52 on page 59*), tap the **User Management** button to open the *Log In* screen (see *Figure 70 on page 79*).
2. Tap the **User** button and select either **Admin** or **Operator** from the drop-down list.
3. Tap the **Password** text box and use the keypad to enter your assigned password. Then, tap the **Check** button to enter your password.
4. Tap the **Log In** button to open the *Remote User Management* screen (see *Figure 71 on page 80*).
5. To add a new user (up to three total) tap the **Add User** button in the top right corner of the screen. Then, complete the **User**, **Password** and **Confirm Password** text boxes. When finished, tap the *Check* button and then the **Return** button.
6. To *Set User Access*, tap the **User** button and select the desired user from the drop-down list. Then, use the **Remove** and **Change Password** buttons to configure this user account as desired.
7. Use the two buttons at the bottom of the screen (**Change Settings and Remote Access**) to set the *permissions* for the selected user. Buttons highlighted in blue indicate that the user has access to those operations.
8. When you are finished, tap the **Return** button twice to return to the *Configuration Menu*.



## 6.8 Setting Up a Remote Connection to a PC

As a practical example of using the communications features described in the previous sections, the procedure for connecting the moisture.IQ to a remote **PC** via a *Local Area Network (LAN)* is described below.

1. Ensure that the **PC** is properly connected to the **LAN** and that the user has logged in.
2. Refer to “Configuring the Ethernet TCP/IP Connection” on page 77, and ensure that the *TCP/IP* connection is **Enabled** and that the *IP Address* is set to **Automatic**.
3. Refer to “Configuring a VNC Connection” on page 82, and ensure that the *VNC Server* is **Enabled**.
4. Use a standard *ethernet cable* to connect the *ethernet port* on the back of the moisture.IQ to the **LAN**. Then, open the *TCP/IP Setup* screen and record the *IP Address* shown in the text box.
5. From the **PC**, go to the **RealVNC** web site and download the *VNC Viewer*. Then, launch the *VNC Viewer* and enter the recorded moisture.IQ *IP Address* when prompted (see *Figure 74* below). Click the **Connect** button.

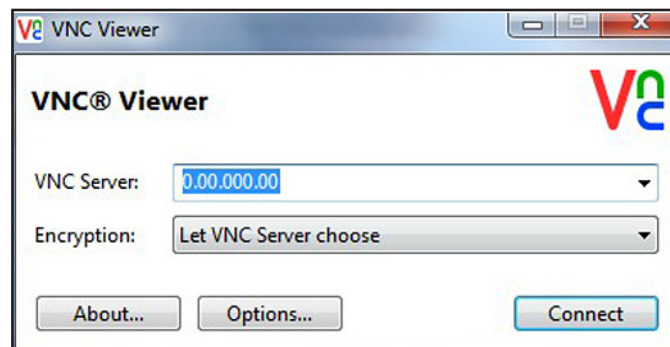

**Figure 74: VNC Viewer Screen**

6. A *Log In* screen should now be open on the moisture.IQ. Enter your **Password** and **Log In**. The moisture.IQ display should now be replicated on your PC monitor.
7. You can now control the moisture.IQ remotely by using your *mouse* to *click* on the display buttons. Note that *keyboard* input from the PC is not accepted by the moisture.IQ.

[no content intended for this page]

## Chapter 7. Maintenance



**WARNING!** Do not attempt maintenance of the moisture.IQ beyond the instructions in this section. If you do, you may damage the unit and void the warranty.

This chapter covers the following topics:

- “Delta F Oxygen Cell Electrolyte” on page 87
- “Replacing and Recalibrating Moisture Probes” on page 89
- “Calibrating the Delta F Oxygen Cell” on page 89
- “Delta F Oxygen Cell Electrolyte” on page 87

### 7.1 Delta F Oxygen Cell Electrolyte

As a result of operating the moisture.IQ, particularly when monitoring dry gases, there may be a gradual loss of water from the electrolyte. The electrolyte level should be checked at regular intervals to ensure that the cell is always operating properly. This section describes how to check and replenish the electrolyte in the oxygen cell.

**Note:** *Some applications require that the electrolyte be changed periodically. Consult BHGE.*

### 7.1.1 Checking the Electrolyte Level

Using the level indicator window on the oxygen cell, check the electrolyte level. The electrolyte should cover about 60% of the window. The electrolyte level should be between the **Min** and **Max** lines, as shown in *Figure 75* below.

When the *Delta F Oxygen Cell* connections are made to the moisture.IQ, the analyzer can detect the electrolyte level and indicate when it is low. When the electrolyte level is low, all oxygen readings are highlighted in amber and an “*Oxygen Fluid Low*” error message is displayed beneath the measurements.

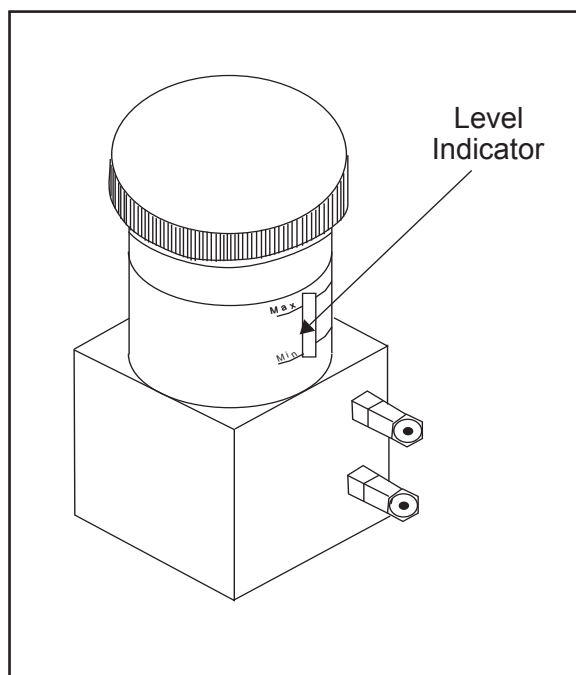

**Figure 75: Electrolyte Level for the Delta F Oxygen Cell**

### 7.1.2 Replenishing the Electrolyte

Once the oxygen cell receives the initial charge of electrolyte, you should monitor the level regularly. **DO NOT** let the fluid level drop below the **MIN** level mark on the window.



**WARNING!** The electrolyte contains a strong caustic component and can be harmful if it comes in contact with the skin or the eyes. Follow proper procedures for handling the caustic (potassium hydroxide) solution. Consult your company safety personnel.

To raise the fluid level in the reservoir, add **DISTILLED WATER** slowly in small amounts. Check the level as you add the distilled water, making sure you do not overfill the reservoir. The electrolyte mixture should cover approximately 60% of the level indicator window.

## 7.2 Replacing and Recalibrating Moisture Probes

For maximum accuracy you should send moisture probes back to the factory for recalibration every six months to one year, depending on the application. Under severe conditions you should send the probes back for recalibration more frequently; in milder applications you do not need to recalibrate probes as often. Contact a BHGE applications engineer for the recommended calibration frequency for your application.

When you receive new or re-calibrated probes, be sure to install and connect them as described in “*Configuring the Probes*” on page 59. After you have installed and connected the probes, enter the calibration data as described in “*Calibrating the Probes*” on page 66. Note that each probe has its own *Calibration Data Sheet* with the corresponding probe serial number printed on it.

You do not have to enter calibration data for the *Moisture Image Series Probes (MISP)* if you returned the **MISP2** probe, or in the case of the original **MIS** probe, both the sensor and the electronics module to the factory for recalibration. However, you should verify that the calibration data entered at the factory is correct (see “*The Probe Configuration Screen*” on page 60). If you sent only the sensor part of the original *Moisture Image Series* probe to BHGE (without the module), you must enter the calibration data manually.

## 7.3 Calibrating the Delta F Oxygen Cell

You should calibrate the Delta F Oxygen Cell when you initially receive it. After that, calibrate the oxygen cell once a month for the first three months, and then as needed. You should also calibrate the oxygen cell if you change the electrolyte.

Calibrating the oxygen cell involves three steps:

- Displaying the oxygen content in PPMv and  $\mu\text{A}$
- Checking the oxygen cell calibration
- Entering the new span value

### 7.3.1 Displaying Oxygen Content in PPMv and $\mu\text{A}$

1. Determine the channel to which the *Delta F Oxygen Cell* is connected.
2. If you are not displaying oxygen data, configure the channel as described in “*The Probe Configuration Screen*” on page 60.

**Note:** A “Channel Not Installed” message appears if you select a channel where no channel module is installed. Select a different channel.

### 7.3.2 Checking the Oxygen Cell Calibration

**Note:** *If your range of measurement is significantly below the span gas you are using, you may elect to input the **PPM O2** content of the span gas and the measured **µA value** instead of using the following procedure.*

To perform this calibration check you must have a calibration gas with a known PPMv value and a sample system with a calibration gas inlet valve. Proceed as follows:

**Note:** *BHGE recommends a span calibration gas be 80-100% of the span of the sensor's overall range in a background of nitrogen (e.g., 80-100 PPM O<sub>2</sub> in N<sub>2</sub> for a 0-100 PPM O<sub>2</sub> sensor).*

1. Initiate flow of the calibration gas through the oxygen cell.
2. Read the PPM<sub>v</sub> value. If it is correct, your oxygen cell does not need calibration. If the reading is incorrect, you must calculate the new span reading (x) from the following equation:

$$x = IO_c + \frac{(OX_1 - OX_c)(IO_c - IO_0)}{(OX_c - OX_0)}$$

where

- OX<sub>c</sub> = Correct PPM<sub>v</sub> for the calibration gas
- OX<sub>0</sub> = Zero value in PPM<sub>v</sub>\*
- OX<sub>1</sub> = Span value in PPM<sub>v</sub>\*
- IO<sub>c</sub> = Actual reading for the calibration gas in µA
- IO<sub>0</sub> = Zero value in µA\*
- x = New span reading in µA

\*See the *Calibration Data Sheet* for the oxygen cell to obtain the necessary zero and span values.

For example, if the calibration data for your cell is as follows:

OX<sub>c</sub> = 75 PPM<sub>v</sub> = Correct PPM<sub>v</sub> for the calibration gas

OX<sub>0</sub> = 0.050 PPM<sub>v</sub> = Zero value in PPM<sub>v</sub>

OX<sub>1</sub> = 100 PPM<sub>v</sub> = Span value in PPM<sub>v</sub>

IO<sub>c</sub> = 290 µA = Actual reading for the calibration gas

IO<sub>0</sub> = 0.4238 µA = Zero value

Then,

$$290 + \frac{(100 - 75)(290 - 0.4238)}{(75 - 0.05)} = x$$

The new **span value (x)** is 100 PPM<sub>v</sub> ≅ 387 µA. Enter the new value as described in “*Calibrating the Probes*” on page 66.

## 7.4 Delta F Oxygen Cell Background Gas Correction Factors

The factory calibration procedure for *Delta F Oxygen Cell* uses nitrogen as the reference background gas. The moisture.IQ will measure oxygen incorrectly if the transport rate of oxygen through the cell diffusion barrier is based on a different background gas. Therefore, if you want to use a background gas other than nitrogen, you must recalibrate the meter for the chosen background gas.

**Note:** *To use the current multipliers in this chapter, your Calibration Data Sheet should contain calibration data for nitrogen. If your calibration data sheet contains data for a background gas other than nitrogen, contact BHGE for the nitrogen calibration sheet.*

### 7.4.1 Correcting for Different Background Gases

A single *Background Gas Correction Factor* based on a reference nitrogen measurement can be derived for each background gas because the diffusion rate for a typical background gas is stable and predictable and because the oxygen cell response is linear.

For example, *Table 9* below lists the calibration values at two points for a specific oxygen cell calibrated with nitrogen as the background gas. Such data is supplied with the oxygen cell and is stored in the user program.

**Table 9: Oxygen Cell Calibration Data (ref. to nitrogen)**

Zero Point Calibration	Zero PPM <sub>v</sub> Value = .0500 PPM <sub>v</sub>
	Zero $\mu$ A Value = .9867 $\mu$ A
Span Point Calibration	Span PPM <sub>v</sub> Value = 100.0 PPM <sub>v</sub>
	Span $\mu$ A Value = 300.1 $\mu$ A

If this oxygen cell is used in a background gas other than nitrogen, you must enter the gas's correction factor, as listed in *Table 10* on page 92. Then, the moisture.IQ will apply the appropriate correction to the measured oxygen signal. Although the original calibration values for nitrogen are programmed into the moisture.IQ, the meter uses the correction factor to determine the actual oxygen concentration.

## 7.4.2 Entering the Background Gas Correction Factor

To change the *Background Gas Correction Factor*, complete the following steps:

**Note:** The default setting for the Correction Factor is 1.00.

1. Select the appropriate *Correction Factor* from Table 10 below.
2. Program the *Correction Factor* as described in “Entering User Constants” on page 72.

**Table 10: Background Gas Correction Factor**

Background Gas	Correction factor			
	Up to 1000 PPM	5000-10,000 PPM	2.5% to 10%	25%
Argon (Ar)	0.97	0.96	0.95	0.98
Hydrogen (H <sub>2</sub> )	1.64	1.96	2.38	1.35
Helium (He)	1.72	2.13	2.70	1.39
Methane (CH <sub>4</sub> )	1.08	1.09	1.11	1.05
Ethane (C <sub>2</sub> H <sub>6</sub> )	0.87	0.84	0.81	0.91
Propylene (C <sub>3</sub> H <sub>6</sub> )	0.91	0.88	0.87	0.93
Propane (C <sub>3</sub> H <sub>8</sub> )	0.79	0.76	0.72	0.58
Butene (C <sub>4</sub> H <sub>8</sub> )	0.69	0.65	0.60	0.77
Butane (C <sub>4</sub> H <sub>10</sub> )	0.68	0.63	0.58	0.76
Butadiene (C <sub>6</sub> H <sub>6</sub> )	0.71	0.66	0.62	0.79
Acetylene (C <sub>2</sub> H <sub>2</sub> )	0.95	0.94	0.93	0.97
Hexane (C <sub>6</sub> H <sub>14</sub> )	0.57	0.52	0.89	0.67
Cyclohexane (C <sub>6</sub> H <sub>12</sub> )	0.64	0.58	0.54	0.72
Vinyl Chloride (CH <sub>2</sub> CHCl)	0.74	0.69	0.65	0.81
Vinylidene Chloride (C <sub>2</sub> H <sub>2</sub> F <sub>2</sub> )	0.77	0.73	0.69	0.83
Neon (Ne)	1.18	1.23	1.28	1.11
Xenon (Xe)	0.70	0.65	0.61	0.78
Krypton (Kr)	0.83	0.79	0.76	0.88
Sulfur Hexafluoride (SF <sub>6</sub> )	0.54	0.49	0.44	0.64
Freon 318 (C <sub>4</sub> F <sub>8</sub> )	0.39	0.34	0.30	0.49
Tetrafluoromethane (CF <sub>4</sub> )	0.62	0.57	0.52	0.71
Carbon Monoxide (CO)	0.99	0.99	0.98	0.99



## Chapter 8. Troubleshooting

The moisture.IQ is designed to be maintenance and trouble free; however, because of process conditions and other factors, minor problems may occur. Some of the most common problems and procedures are discussed in this section. If you cannot find the information you need in this section, please consult BHGE.



**WARNING!** Do not attempt to troubleshoot the moisture.IQ beyond the instructions in this section. If you do, you may damage the unit and void the warranty.

This chapter covers the following topics:

- Screen Messages (see “Screen Messages” below)
- Common Problems (see “Common Problems” on page 96)

### 8.1 Screen Messages

The moisture.IQ has several screen messages that may display during operation. Refer to *Table 11* below for a list of these messages and the possible causes.

**Table 11: Screen Messages and the Possible Causes**

Screen Message	Possible Cause	System Response	Action
CHANNEL NOT AVAILABLE	Module not installed	None	Select a different channel.
NO PROBE	Unit has not been configured for the probe activated. For example, you cannot display pressure on a channel where only an M Series probe is configured.	None	Make sure the correct probe is activated as described on page 60.  Connect the required probe.
NOT AVAILABLE	The mode and/or units selected require more data or need a different probe. For example, you cannot read %RH with a moisture probe that does not have the temperature option.	None	Choose a different mode and/or units as described on page 60.  Connect the required probe.

**Table 11: Screen Messages and the Possible Causes (cont.)**

Screen Message	Possible Cause	System Response	Action
MIS NO LINK	Communication with a Moisture Image Series Probe has failed. The Moisture Image Series Probe is disconnected or damaged.	After the moisture.IQ performs 5 checks, it replaces data with the following default values: dew point = -110°C temperature = 70°C pressure = 0 psi.	Check the Moisture Image Series Probe connections.  Replace the Moisture Image Series Probe.
Chan X: MIS BAD CRC (CRC - Cyclic Redundancy Check)	Communication link with Moisture Image Series Probe is established, but data is intermittent or distorted.	No Link Error	Check for cable breaks or high electro magnetic interference (EMI).
ADC Failure!	Primary A/D converter has failed.	Returns to zero.	Return unit for service.
f ( ): Invalid	User function invalid.	User function invalid.	Reenter or check user function.
f ( ): Div. by 0	User function attempted to divide by zero.	Error message.	Check logic of user function.
fp ( ): Math error	User function attempted illegal operation, such as the square root of -2.	Error message.	Check logic of user function.
f ( ): Missing #	User function has missing operand for an operator	Error message.	Check user function.
f ( ): Extra #	User function has extra operand or missing operator.	Error message.	Check user function.
f ( ): Missing Op	User function has missing operator or extra operand.	Error message.	Check user function.
f ( ): Extra Op	User function has extra operator or missing operand.	Error message.	Check user function.
f ( ): Too Complex	User function has too many terms, or the constant has >23 digits.	Error message.	Check user function.
f ( ): Missing (	User function has unbalanced parentheses.	Error message.	Add missing parentheses.
f ( ): Missing)	User function has unbalanced parentheses.	Error message.	Add missing parentheses.
Under Range (See Range Error Description on page 52.)	The input signal is below the calibrated range of the probe.	Alarms and outputs respond as programmed. Refer to Chapter 4.	If measurement is not expected to be below scale, send probe to BHGE for evaluation.

**Table 11: Screen Messages and the Possible Causes (cont.)**

Screen Message	Possible Cause	System Response	Action
Over Range (See <i>Range Error Description</i> on page page 52.)	The input signal is above the calibrated range of the probe.	Alarms and outputs respond as programmed. Refer to Chapter 4.	Change the measurement units so that the measurement is within range. For example, change ppb to ppm. Refer to page 60. If measurement is not expected to be above scale, send probe to BHGE for evaluation.
"Mode" Fault! – "Mode" is replaced by one of the available measurement modes.	The input signal from the probe exceeds the capacity of the analyzer electronics.	Alarms and outputs respond as programmed. Refer to Chapter 4.	If measurement is not expected to be above scale, check wiring for shorts, and if none are apparent, send probe to BHGE for evaluation.
Cal Error	During Auto-Cal, an internal reference is found to be outside its acceptable range.  Signal Error has occurred.	Alarms and outputs respond as programmed. Refer to Chapter 4.	Make sure the analyzer is grounded properly.  Make sure the ground bolt is installed on the channel card.  Remove source of Signal Error and attempt another Auto-Cal.  Contact BHGE.

## 8.2 Common Problems

If the moisture.IQ measurement readings seem strange or do not make sense, there may be a problem with the probe or the process system. *Table 12* below contains some of the most common measurement problems.

**Table 12: Troubleshooting Guide for Common Problems**

Symptom	Possible Cause	System Response	Action
Accuracy of moisture sensor is questioned.	Insufficient time for system to equilibrate	Probe reads too wet during dry down conditions, or too dry in wet up conditions.	Change the flow rate. A change in dew point indicates the sample system is not at equilibrium, or there is a leak. Allow sufficient time for the sample system to equilibrate and the moisture reading to become steady. Check for leaks.
	Dew point at sampling point is different than the dew point of the main stream.	Probe reads too wet or too dry.	Readings may be correct if the sampling point and main stream do not run under the same process conditions. Different process conditions cause readings to vary. If sampling point and main stream conditions are the same, check sample system pipes, and any pipe between the sample system and main stream for leaks. Also, check sample system for adsorbing water surfaces, such as rubber or plastic tubing, paper-type filters, or condensed water traps. Remove or replace contaminating parts with stainless steel parts.
	Sensor or sensor shield affected by process contaminants (refer to <i>Basic Hygrometry Principles</i> ).	Probe reads too wet or too dry.	Clean the sensor and the sensor shield as described in document 916-064, <i>Basic Hygrometry Principles</i> . Then reinstall sensor.
	Sensor is contaminated with conductive particles (refer to <i>Basic Hygrometry Principles</i> ).	Probe reads high dew point.	Clean the sensor and the sensor shield as described in document 916-064, <i>Basic Hygrometry Principles</i> . Then reinstall sensor.
	Sensor is corroded (refer to <i>Basic Hygrometry Principles</i> ).	Probe reads too wet or too dry.	Return probe to factory for evaluation.
	Sensor temperature is greater than 70°C (158°F).	Probe reads too dry.	Return probe to factory for evaluation.
	Stream particles are causing abrasion.	Probe reads too wet or too dry	Return probe to factory for evaluation.

**Table 12: Troubleshooting Guide for Common Problems (cont.)**

Symptom	Possible Cause	System Response	Action
Screen always reads the wettest (highest) programmed moisture calibration value while displaying dew/frost point.	Probe is saturated. Liquid water present on sensor surface and/or across electrical connections.		Clean the sensor and the sensor shield as described in document 916-064, <i>Basic Hygrometry Principles</i> Then reinstall sensor.
	Shorted circuit on sensor.		Run “dry gas” over sensor surface. If high reading persists, then probe is probably shorted and should be returned to the factory for evaluation
	Sensor is contaminated with conductive particles (refer to <i>Basic Hygrometry Principles</i> ).		Clean the sensor and the sensor shield as described in document 916-064, <i>Basic Hygrometry Principles</i> . Then reinstall sensor.
	Improper cable connection.		Check the cable connections to both the probe and the moisture.IQ.
Screen always reads the driest (lowest) programmed moisture calibration value while displaying dew/frost point.	Open circuit on sensor.		Return probe to factory for evaluation.
	Non-conductive material is trapped under contact arm of sensor.		Clean the sensor and the sensor shield as described in document 916-064, <i>Basic Hygrometry Principles</i> . Then reinstall the sensor. If the low reading persists, return the probe to the factory for evaluation.
	Improper cable connection.		Check the cable connections to both the probe and the moisture.IQ.
Slow response.	Slow outgassing of system.		Replace the system components with stainless steel or electro-polished stainless steel.
	Sensor is contaminated with non-conductive particles (refer to <i>Basic Hygrometry Principles</i> ).		Clean the sensor and the sensor shield as described in document 916-064, <i>Basic Hygrometry Principles</i> . Then reinstall the sensor.
Exception screen	Unrecoverable software error.		Contact BHGE.

[no content intended for this page]

## Chapter 9. Specifications

### 9.1 Electronics

#### Intrinsic Safety

All non-auxiliary inputs are intrinsically safe through internal isolation and energy-limiting circuitry.

#### Inputs

Two module bays are available. Each module bay can accommodate a 1-channel or 3-channel module. Each channel can accept:

- 1 Moisture input (MIS probe or M-Series probe)
- 1 Temperature input (MIS Probe or M-Series probe)
- 1 Pressure input (MIS probe)
- 1 Oxygen input (electrochemical sensor)
- 2 Auxiliary inputs

#### Analog Outputs

2 per available channel

#### High/Low Measurement Alarm Relays

2 per available channel

#### System Fault Condition Alarm Relay

1 available (not channel specific)

#### Dimensions (w x h x d, Weights and IP/NEMA Rating

- *Rack Mount*: 482 x 133 x 357 mm (19.0 x 5.2 x 14.1 in.); 11.2 kg (24.7 lb)
- *Bench Mount*: 440 x 133 x 357 mm (17.4 x 5.2 x 14.1 in.); 10.4 kg (22.9 lb)
- *Panel Mount*: 542 x 201 x 357 mm (21.4 x 8.0 x 14.1 in.); 11.3 kg (25.0 lb)
- *Weatherproof Stainless Steel*: 508 x 508 x 229.8 mm (20.0 x 20.0 x 9.05 in.); 24.9 kg (55 lb); IP 66; Type 4X
- *Weatherproof Fiberglass*: 612.5 x 625 x 243 mm (24.11 x 24.61 x 9.57 in.); 24.9 kg (55 lb); Type 4X
- *Explosion-Proof*: 590.6 x 590.6 x 304.8 mm (23.25 x 23.25 x 12.0 in.); 113.6 kg (250 lb); IP 66; Type 4X

**Note:** See BHGE drawing 712-1889 in the CSS document at the end of this manual.

#### Power

- *AC configuration*: Universal power supply adjusts automatically from 100 to 240 VAC, 50/60 Hz, 60 Watts maximum, fuse T4A, 250 VAC, 5 x 20 mm
- *DC configuration*: 24 V nominal ( $\pm 10\%$ ), 60 Watts maximum

## 9.2 Moisture Measurement

### Type

BHGE Moisture Image Series and M-Series thin-film aluminum oxide probes.

### Calibration Ranges (Dew/Frost Point)

- *Standard*: +10 to -80°C (+50 to -112°F), with data from +20 to -110°C (+68 to -166°F)
- *Ultralow*: -50 to -100°C (-58 to -148°F), with data to -110°C (-166°F)

### Accuracy (Dew/Frost Point)

- $\pm 2^{\circ}\text{C}$  ( $\pm 3.6^{\circ}\text{F}$ ) from +10 to -65°C (+50 to -85°F)
- $\pm 3^{\circ}\text{C}$  ( $\pm 5.4^{\circ}\text{F}$ ) from -66 to -80°C (-86 to -112°F)

### Repeatability (Dew/Frost Point)

- $\pm 0.5^{\circ}\text{C}$  ( $\pm 0.9^{\circ}\text{F}$ ) from +10 to -65°C (+50 to -85°F)
- $\pm 1.0^{\circ}\text{C}$  ( $\pm 1.8^{\circ}\text{F}$ ) from -66 to -80°C (-86 to -112°F)

### Operating Pressure

5  $\mu$  of Hg to 5000 psig (345 bar), limited by optional pressure sensor  
(see “Full-Scale Ranges Available” on page 101)

## 9.3 Temperature Measurement

### Type

Optional thermistor built into moisture probe

### Calibration Ranges (Dew/Frost Point)

-30 to +70°C (-22 to +158°F)

### Accuracy

$\pm 0.5^{\circ}\text{C}$  ( $\pm 0.9^{\circ}\text{F}$ ) at -30°C (-22°F)



## 9.4 Pressure Measurement

### Type

- Optional transducer built into Moisture Image Series moisture probes
- Standard external pressure transmitter

### Full-Scale Ranges Available

- 30 to 300 psig
- 50 to 500 psig
- 100 to 1000 psig
- 300 to 3000 psig
- 500 to 5000 psig

### Accuracy

±1% of full scale

### Pressure Rating

Three times the span of the available range, to a maximum of 7500 psig (518 bar)

## 9.5 Oxygen Measurement

### Type

Electrochemical sensor

### Ranges Available

- 0 to 0.5 / 5 / 50 ppm
- 0 to 1 / 10 / 100 ppm
- 0 to 10 / 100 / 1000 ppm
- 0 to 100 / 1000 / 10,000 ppm
- 0 to 50 / 500 / 5000 ppm
- 0 to 5%
- 0 to 10%
- 0 to 25%

### Accuracy

- ±1% full scale (ranges >0-2.5 PPM<sub>v</sub>)
- ±5% full scale (ranges <0-2.5 PPM<sub>v</sub>)

### Pressure Rating

0.2 to 1 psig (0.07 bar)

## 9.6 General Specifications

### Display

Resistive WVGA, 800 (H) x 480 (V) pixels with touch screen

### Display Functions

Display up to 12 channel/parameter combinations simultaneously using text and/or graphics

### Operating Temperature

-20 to +60°C (-4 to +140°F)

### Storage Temperature

-40 to +70°C (-40 to +158°F)

### Auto-Calibration

Occurs on power up and at user-selectable time intervals

### Warm-up Time

Meets specified accuracy within 5 minutes of turn-on

### Data Logging

Up to six simultaneous logs per storage device, with up to 16 parameters each, stored in 4 GB Micro SDHC

## 9.7 Output Specifications

### Analog

Six per 3-CH module, two per 1-CH module

Internally isolated

12 bit (0.025% Resolution)

### Standard Switch-Selectable Outputs

- 0 to 2 V, 10K ohm minimum load resistance
- 0 to 20 mA, 400 ohm maximum series resistance
- 4 to 20 mA, 400 ohm maximum series resistance

Each output can correspond to any one parameter on that channel. Zero and Span are user-programmable within the range of the instrument and the corresponding sensor.

### Digital Outputs

- Choice of **RS232** or **RS485** serial communications port. Available *baud rates* include: 9600, 19200, 38400, 57600, 115200
- **USB A:** Compliant to **USB 1.1**, master, host for USB storage
- **USB B:** Compliant to **USB 1.1**, slave (factory use only)
- **Ethernet:** RJ-45, supports **10BASE-T** and **100BASE-TX**

### Alarm Relays

Six per 3-CH module, two per 1-CH module. 1 Form C relay SPDT, rated for 2 amps at 28 VDC/28 VAC. Available for high and low limits. The relay contacts can be set to trip at any numerical level within the range of the instrument.

### Output Updating

The microprocessor samples, processes data, and calculates values for each channel sequentially. The minimum update time is 1 second depending on configuration and mode. Channels are updated sequentially.

## 9.8 Input Specifications

### Capability

**Note:** *Each module can be configured as one or three channels.*

1 to 6 channels moisture

1 to 6 channels temperature

1 to 6 channels pressure

1 to 6 channels oxygen

2 auxiliary inputs per installed channel

**Note:** *Inputs may be used for 0 to 2 mA, 4 to 20-mA, and voltage-based transmitter in the -1 to +4-V range including devices such as Oxygen Analyzers, Thermal Conductivity Analyzers, Flowmeters, Pressure Transmitters, Temperature Transmitters, etc.*

### Resolution

16 bits

### Moisture Sensor Probes

*BHGE types: M-Series, Moisture Image Series, and MISP2*

### Temperature Sensor

Thermistor (optionally supplied as part of the moisture probe assembly)

### Pressure Transmitter

A pressure transducer is optionally available for Moisture Image Series probes. BHGE P40, P40X, or equivalent 4-20 mA, current-transmitting, pressure transducer. Scale factors are entered as part of the user-program sequence.

### Intrinsic Safety

Built-in intrinsic safety provided for all inputs per drawing #752-364, excluding auxiliary inputs

## 9.9 Probe Specifications

### Moisture Image Series Probe (MISP or MISP2)

- Type: Aluminum oxide moisture sensor probe and electronics module
- Calibration: Each sensor is individually computer calibrated against known moisture concentrations, traceable to national standards.
- Process Temperature: -110 to +70°C (-166 to +158°F) dew/frost point temperature
- Storage Temperature: 70°C (158°F) maximum
- Operating Pressure: 5  $\mu$  of Hg to 5000 psig
- Flow Range
  - Gases: Static to 10,000 cm/sec linear velocity at 1 atm
  - Liquids: Static to 10 cm/sec linear velocity at 1 g/cc
  - Response Time: <5 seconds for 63% step change in moisture content in either wet up or dry down cycle
- Moisture Image Series Probe/Analyzer Separation: 915 m (3000 ft) with provided cable

**Note:** *Sale of the MISP probe was discontinued by BHGE in 2010 and it was replaced by the MISP2 probe. Although the MISP probe can be used successfully with the moisture.IQ analyzer, there may be communication issues when using long cables. Please contact our BHGE technical support team for assistance.*

- Moisture Image Series Probe/Analyzer Cable: Unshielded, twisted pair, maximum loop resistance of 100  $\Omega$
- Built-in Temperature Sensor (optional):
  - Type: Thermistor network
  - Operating Range: -30 to +70°C (-22 to +158°F)
  - Accuracy:  $\pm 0.5^\circ\text{C}$  overall
- Built-in Pressure Sensor (optional)
  - Type: Solid state/piezoresistive
  - Available Ranges: 30 to 300 psig, 50 to 500 psig, 100 to 1000 psig, 300 to 3000 psig, 500 to 5000 psig
  - Accuracy:  $\pm 1\%$  of span

## M Series Probe

- Type: Aluminum oxide moisture sensor probe (patented)
- Impedance Range: 50 k $\Omega$  to 2 M $\Omega$  at 77 Hz (depending on vapor pressure of water)
- Calibration: Each sensor is individually computer-calibrated against known moisture concentrations, traceable to national standards.
- Operating Temperature: -110 to +70°C (-166 to +158°F)
- Storage Temperature: maximum of 70°C (158°F)
- Operating Pressure (depends on mount)
  - M1: 5 microns Hg to 75 psig
  - M2: 5 microns Hg to 5000 psig
- Flow Range
  - Gases: From static to 10,000 cm/sec linear velocity at 1 atm
  - Liquids: From static to 10 cm/sec linear velocity at density of 1 g/cc
- Built-in Temperature Sensor
  - Type: Non-linear thermistor
  - Range: -30°C to +70°C (-22°F to +158°F)
  - Accuracy:  $\pm 0.5^\circ\text{C}$  ( $\pm 0.33^\circ\text{F}$ ) overall
  - Response Time: Maximum 1 second in well stirred oil, 10 seconds in still air for a 63% step change in increasing or decreasing temperature

## Delta F Oxygen Cell

- Type: Non-depleting coulometric electrolytic oxygen sensing cell
- Available Cells
  - ppb O<sub>2</sub> Range: DFOX-1, 0 to 500 ppb/ 5 ppm/ 50 ppm, 1/4 VCR ±3% of reading or 25 ppb
- ppm O<sub>2</sub> Range
  - DFOX-9, 0 to 1/10/100 ppm, 1/4 VCR
  - DFOX-2, 0 to 1/10/100 ppm, 1/8 compression ±3% of reading or 50 ppb
  - DFOX-3, 0 to 10/100/1000 ppm, 1/8 compression ±3% of reading or 200 ppb
  - DFOX-4, 0 to 100/1000/10,000 ppm, 1/8 compression ±3% of reading or 2 ppm
  - DFOX-5, 0 to 50/500/5,000 ppm, 1/8 compression ±3% of reading or 1 ppm
- % O<sub>2</sub> Range
  - DFOX-6, 0 to 5%, 1/8 compression ±3% of reading or 10 ppm
  - DFOX-7, 0 to 10%, 1/8 compression ±3% of reading or 20 ppm
  - DFOX-8, 0 to 25%, 1/8 compression ±3% of reading or 50 ppm
- Sensitivity: less than 5 ppb (0 to 500 ppbv range)
- Response Time: fast response to O<sub>2</sub> change, equilibrium time is application specific
- Ambient Temperature: 32 to 120.02°F (0 to 49°C)
- Background Gas Compatibility: STAB-EL® cell: All gas compositions including those containing “acid” gases such as CO<sub>2</sub>, H<sub>2</sub>S, C<sub>12</sub>, NO<sub>x</sub>, SO<sub>2</sub>, etc.

## Hazardous Area Classification

- BASO1ATEX1098X  
II 1G Ex ia IIC T5 Ga  
T<sub>amb</sub> = -4°F to +122°F (-20°C to +50°C)
- US/CAN Class I, Division 1, Groups A, B, C, D, T4

## European Compliance

Complies with EMC Directive 2004/108/EC when connected to a moisture.IQ, Moisture Image® Series 1, Moisture Image® Series 2 or Moisture Monitor™ Series 3 analyzer

### Sample Requirements

- Inlet Pressure: 0.2 to 1.0 psig (0.013 to 0.06 barg), standard range
- Flow Rate: 0.5 to 1.5 SCFH
- Moisture: No limits (avoid condensation)
- Oil/Solvent Mist
  - Less than  $0.5 \text{ mg/ft}^3$  (standard range)
  - Greater than  $0.5 \text{ mg/ft}^3$  (use filter)
- Solid Particles
  - Less than  $2.0 \text{ mg/ft}^3$  (standard range)
  - Greater than  $2.0 \text{ mg/ft}^3$  (use filter)



# Appendix A. Menu Maps

## A.1 The Settings Menu Map

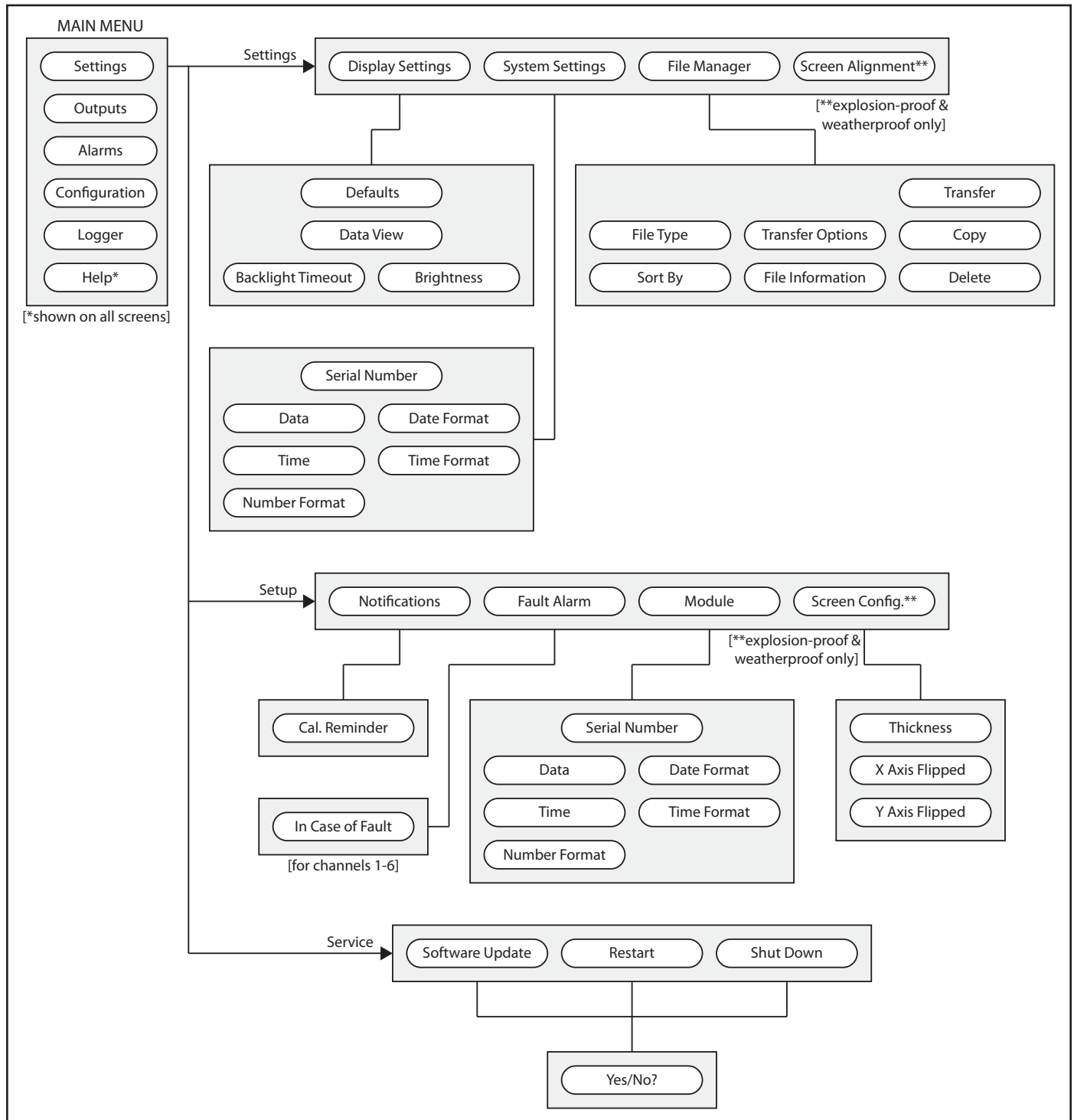
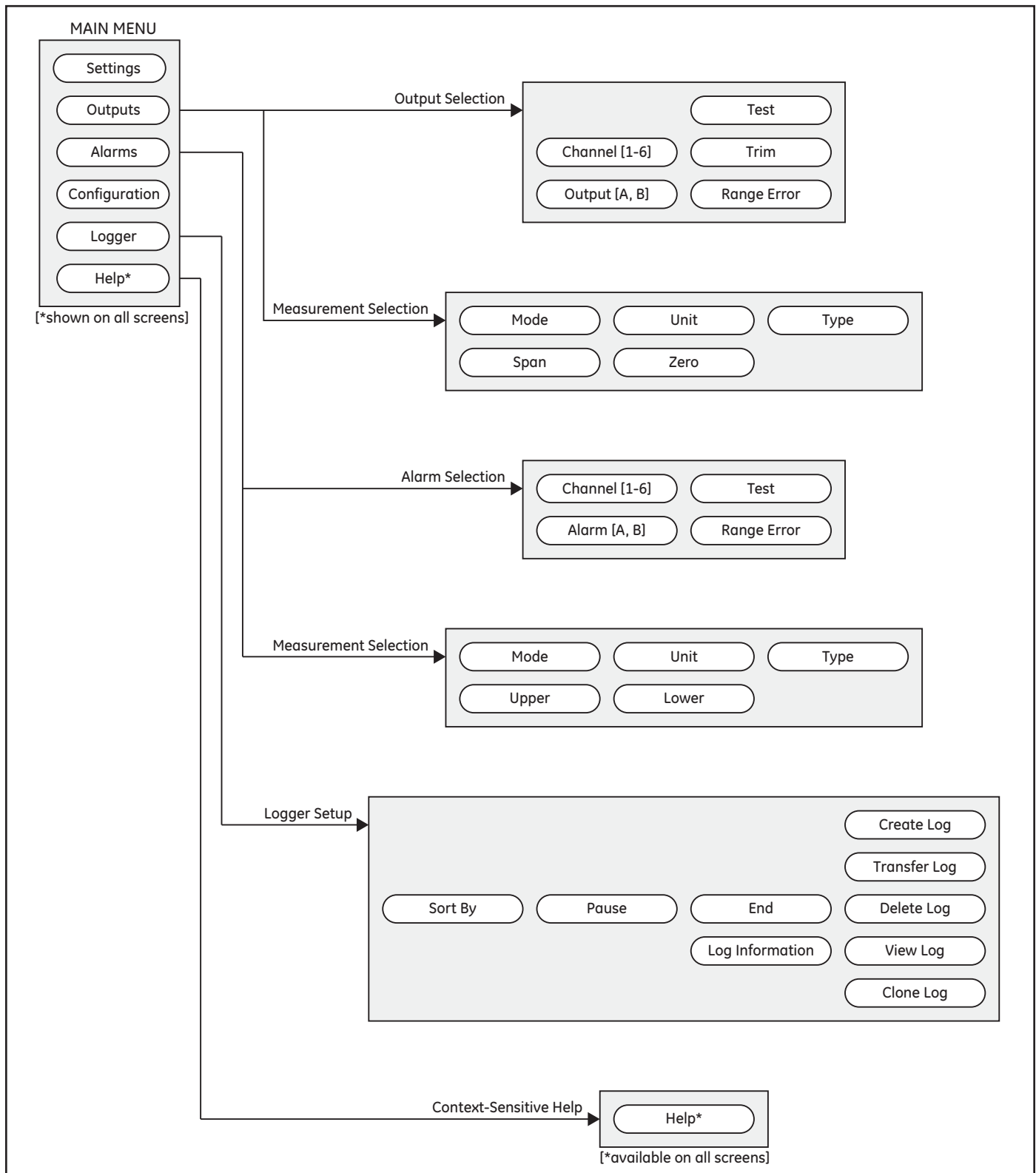

Figure 76: The Settings Menu Map

## A.2 The Outputs, Alarms and Logger Menu Map



**Figure 77: The Outputs, Alarms and Logger Menu Map**

### A.3 The Configuration > Probe & User Menu Maps

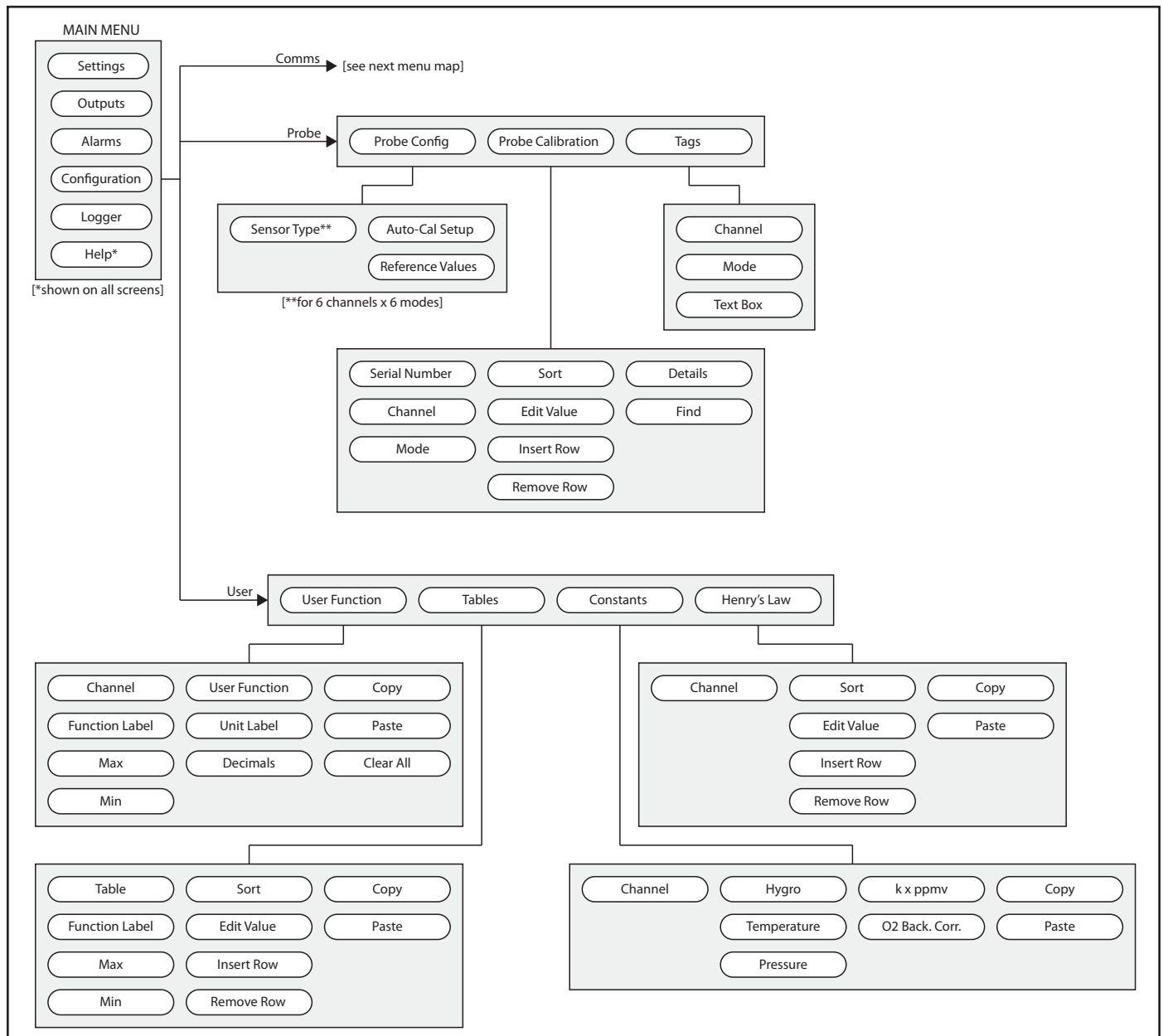

**Figure 78: The Configuration > Probe & User Menu Maps**

## A.4 The Configuration > Comms Menu Map

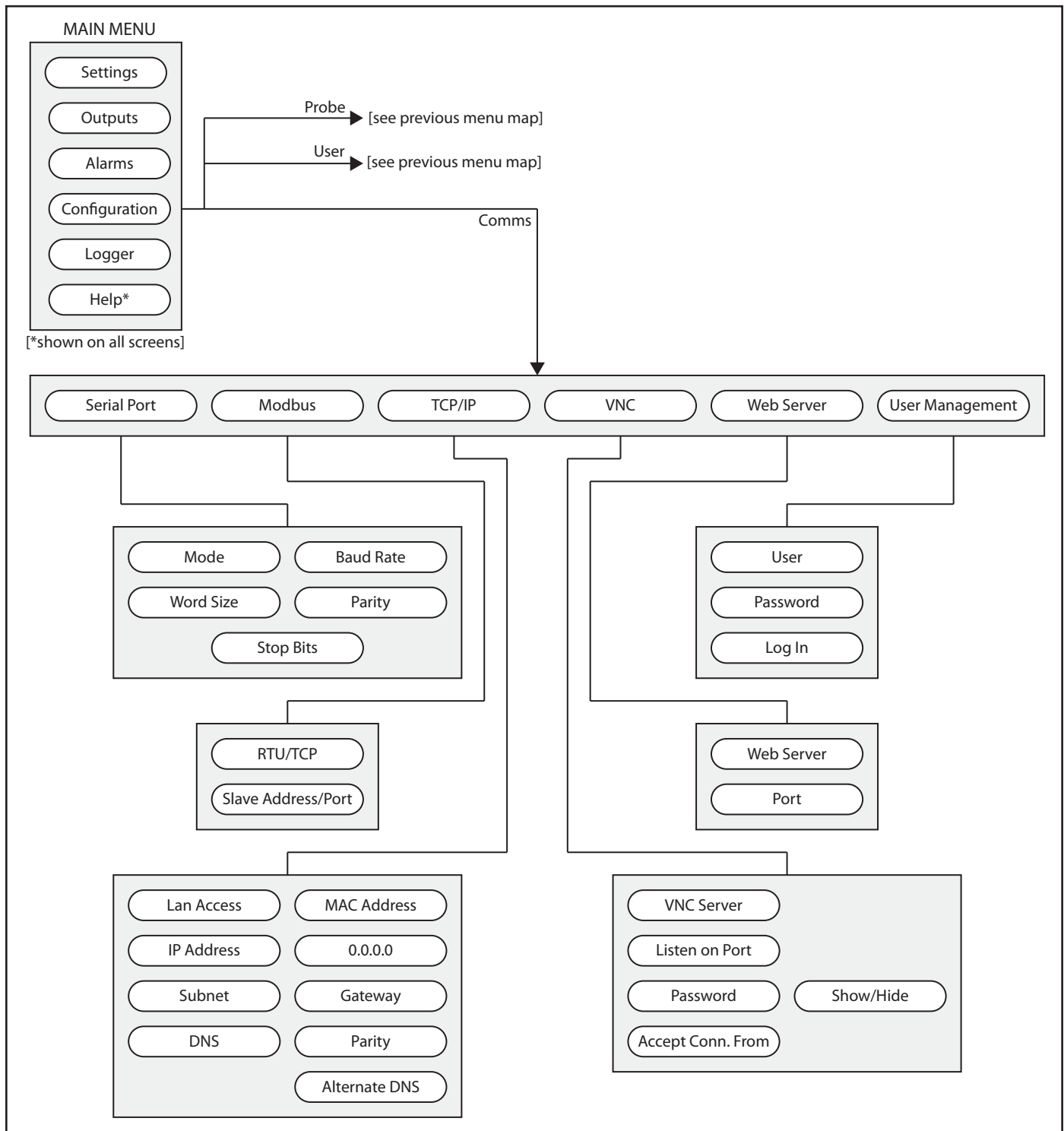

**Figure 79: The Configuration > Comms Menu Map**

# Appendix B. Wiring Diagrams

## B.1 Terminal Blocks

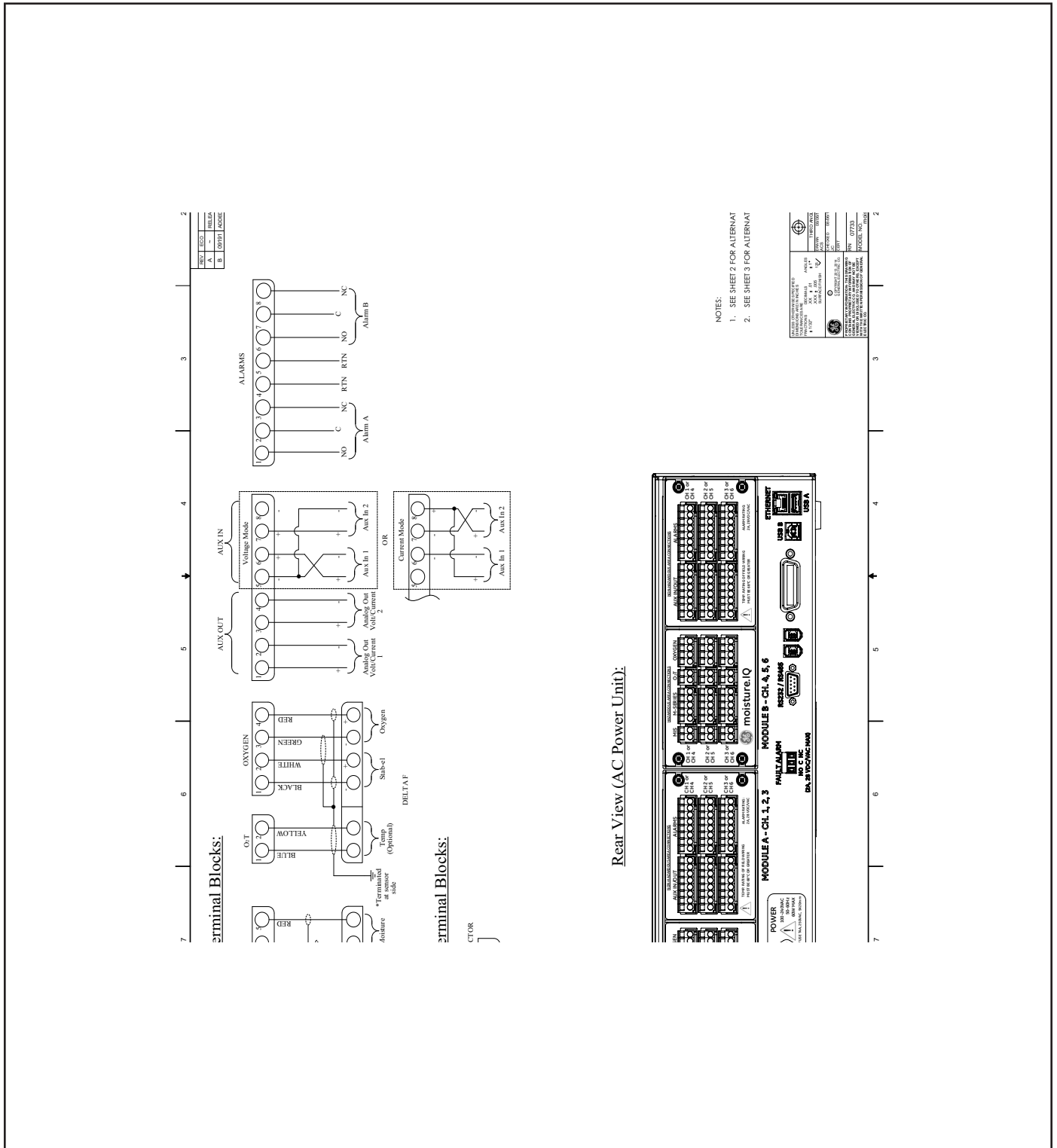

Figure 80: moisture.IQ Wiring – Terminal Blocks and Rear View (Dwg. 702-1542B, SH 1)

## B.2 Rear View Channel Configurations

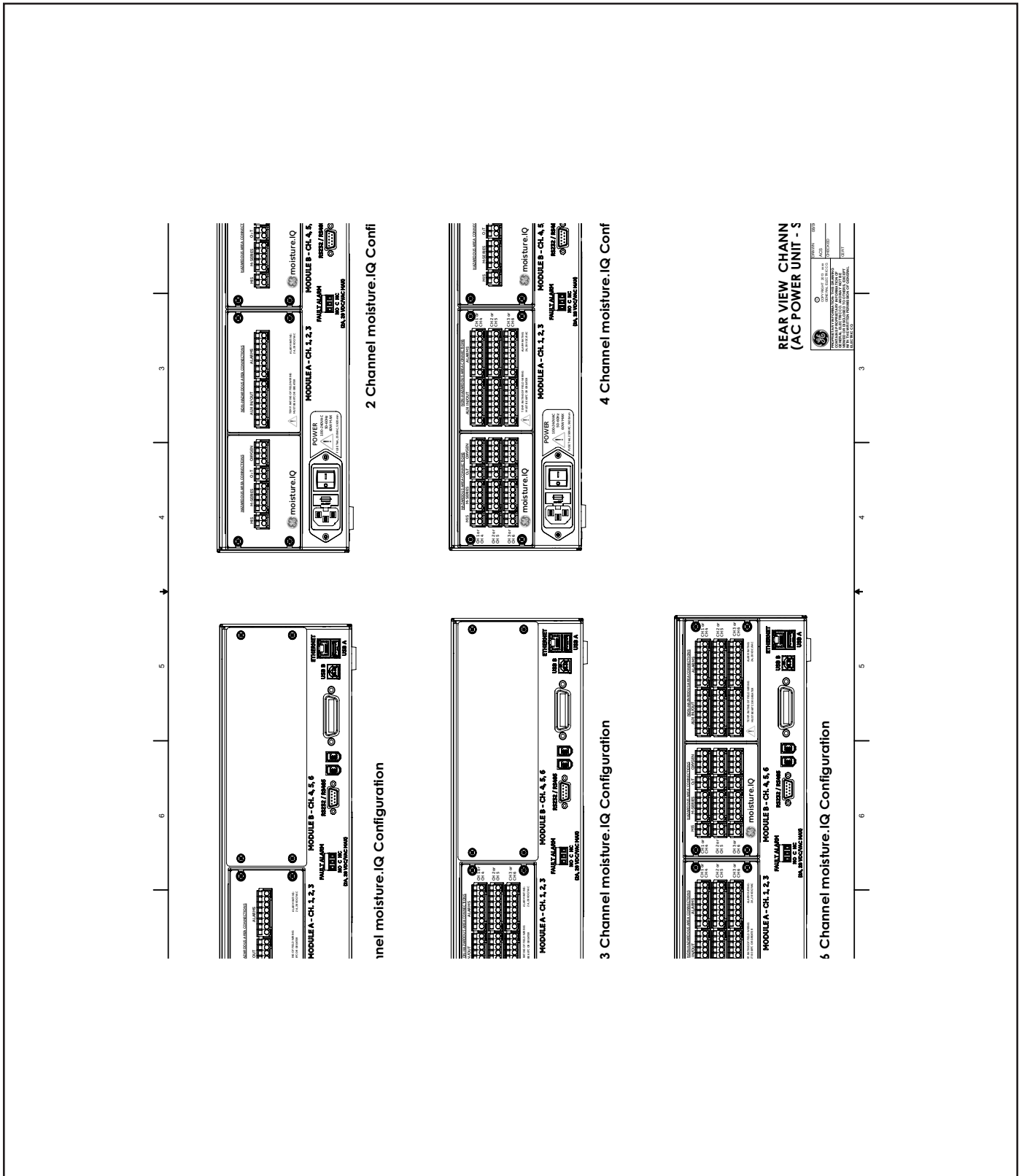

Figure 81: moisture.IQ Wiring – Rear View Channel Configuration (Dwg. 702-1542B, SH 2)

### B.3 Power Wiring

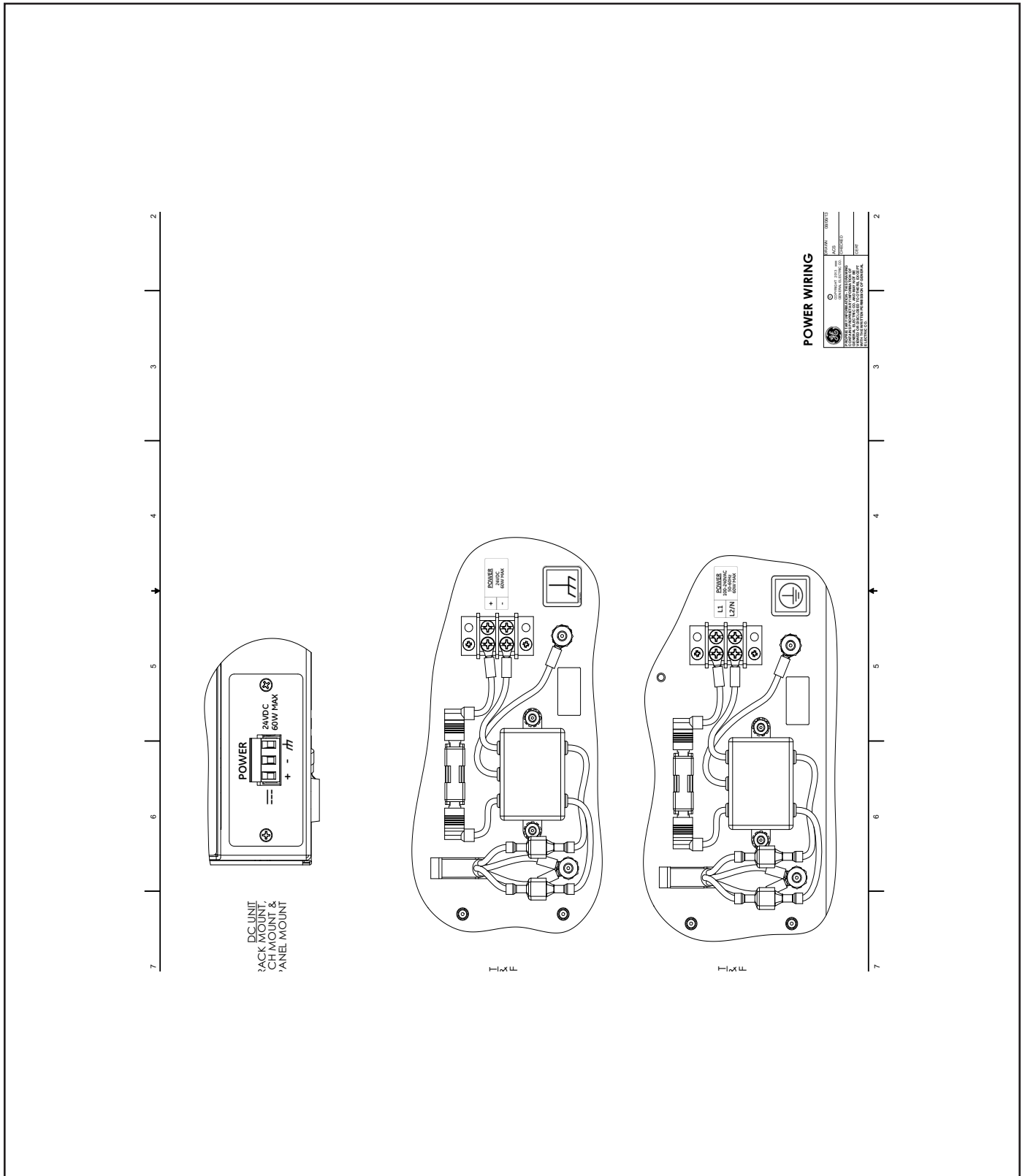

Figure 82: moisture.iQ Wiring – Power Wiring (Dwg. 702-1542B, SH 3)

## B.4 RS-485 Wiring

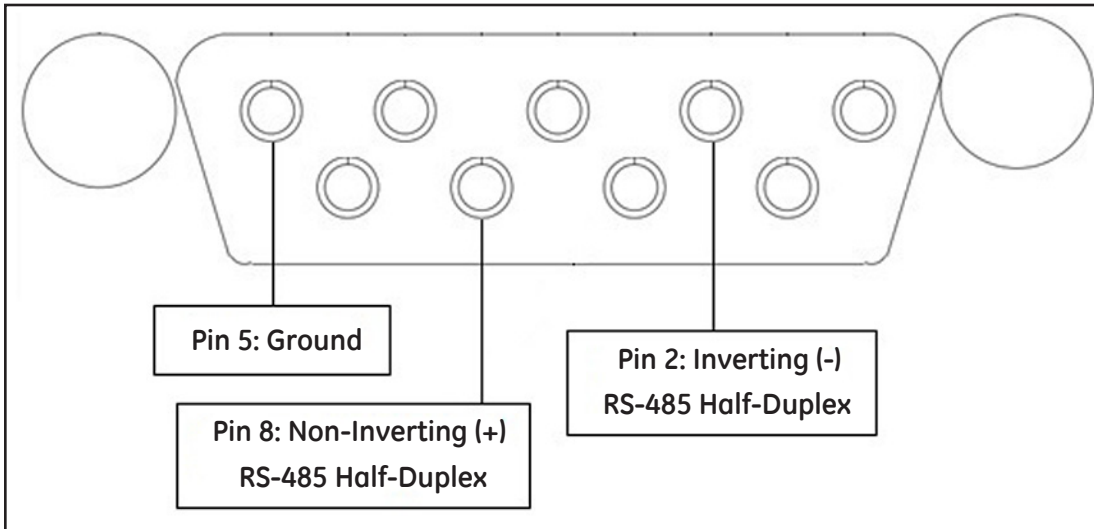

Figure 83: RS-485 Wiring



## Appendix C. Updating the moisture.IQ Firmware

### C.1 Updating the Chassis Firmware

1. Power on the moisture.IQ.
2. Load the updated firmware into the **UPDATE** folder on the USB flash drive.
3. Plug the USB flash drive (with the software update) into the moisture.IQ (see *Figure 84* for Rack/Bench/Panel Mount, *Figure 85* for Weatherproof/Explosion-Proof).



Figure 84: USB Flash Drive Plugged into Rear of Chassis

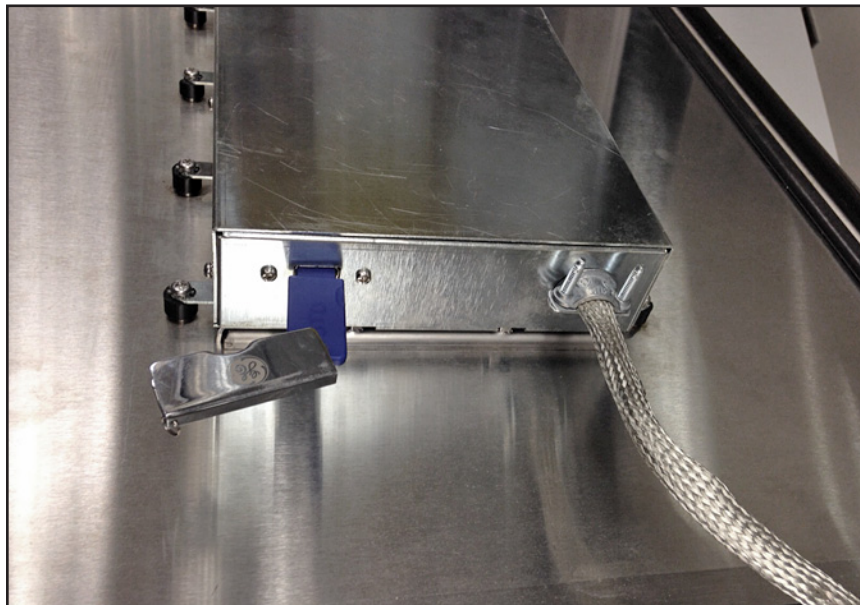
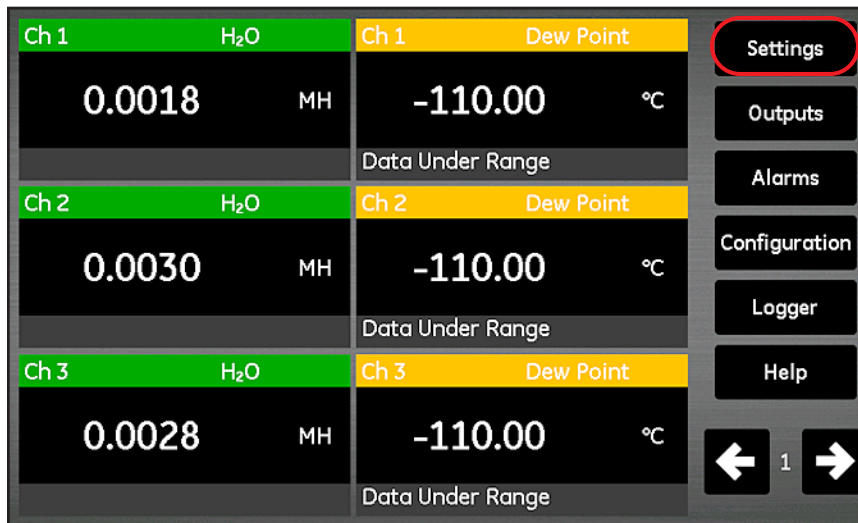

Figure 85: USB Flash Drive Plugged into Chassis Inside the Door

## C.1 Updating the Chassis Firmware (cont.)

- From the main screen, tap the **Settings** button (see *Figure 86* below).



**Figure 86: Settings Button on the Main Screen**

- In the **Service** section (see *Figure 87* below), tap the **Software Update** button. If the **Software Update** button is grayed out, check to ensure that the USB flash drive is properly plugged into the USB port.

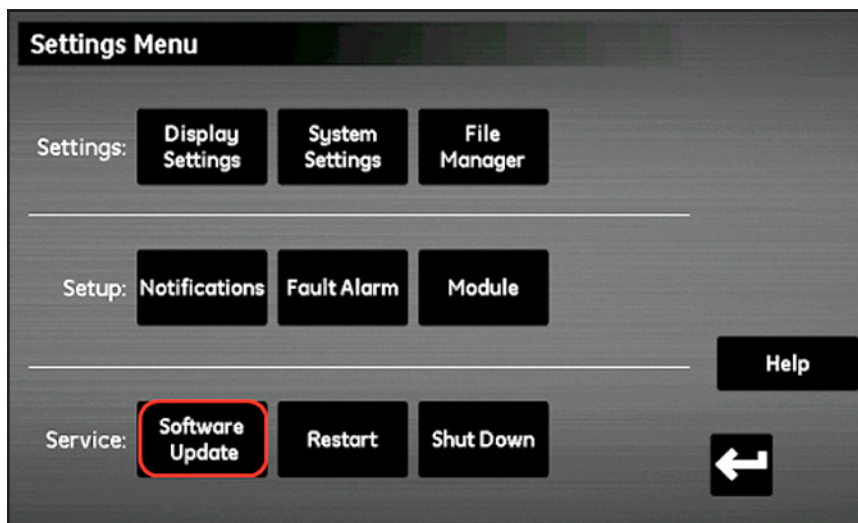

**Figure 87: Software Update**

## C.1 Updating the Chassis Firmware (cont.)

6. The moisture.IQ prompts you to confirm you want to update the software (see *Figure 88* below). Tap the **Yes** button.

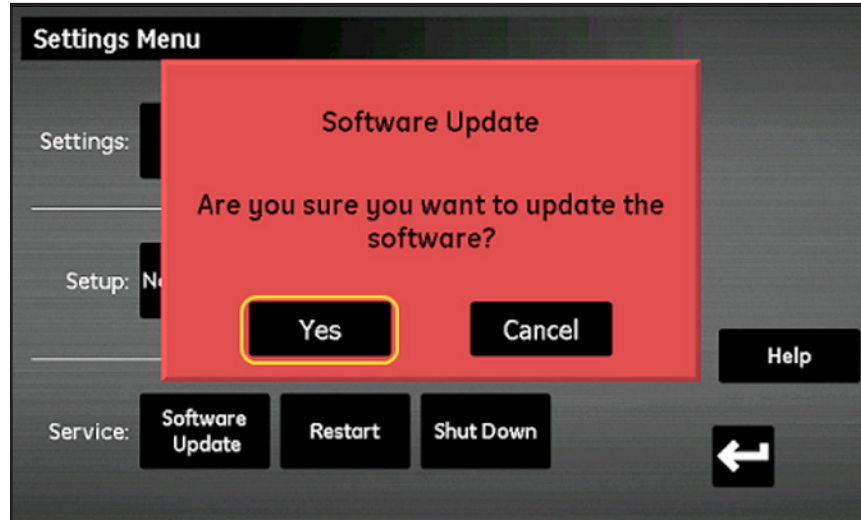

Figure 88: Update Confirmation

Updating the software will take a few minutes, and the screen shown in *Figure 89* below is open during the update.

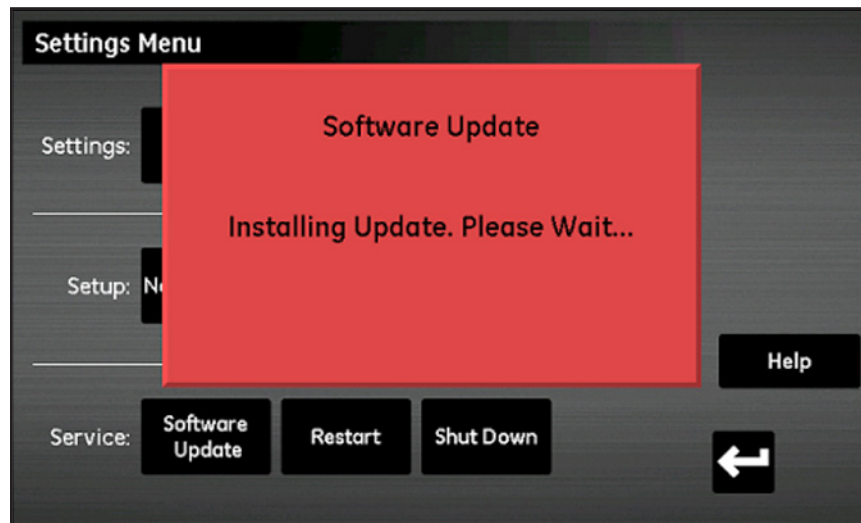

Figure 89: Installing Screen

## C.1 Updating the Chassis Firmware (cont.)

7. After the software update is complete, the meter prompts you to restart the meter (see *Figure 90* below). Tap the **Restart** button to reboot the moisture.IQ.

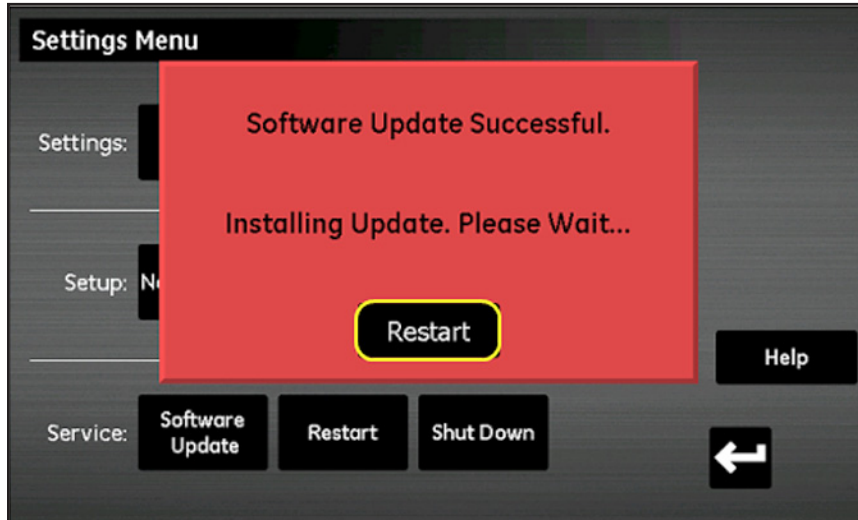

Figure 90: Restart Screen

The unit will reboot with the updated firmware.

## C.2 Updating the moisture.IQ Module Firmware

1. Load the updated firmware into the **UPDATE** folder on the USB flash drive.
2. Plug the USB flash drive (with the software update) into the moisture.IQ (see *Figure 91* for Rack/Bench/Panel Mount, *Figure 92* for Weatherproof/Explosion-Proof.).



**Figure 91: USB Flash Drive Plugged into Rear of Chassis**

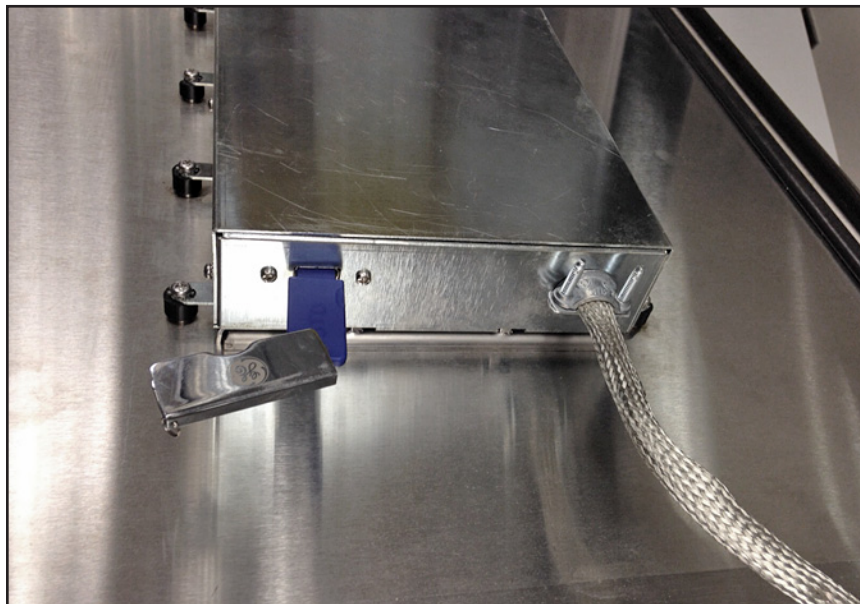

**Figure 92: USB Flash Drive Plugged into Chassis Inside the Door**

## C.2 Updating the moisture.IQ Module Firmware (cont.)

- From the main screen, tap the **Settings** button (see *Figure 93* below).

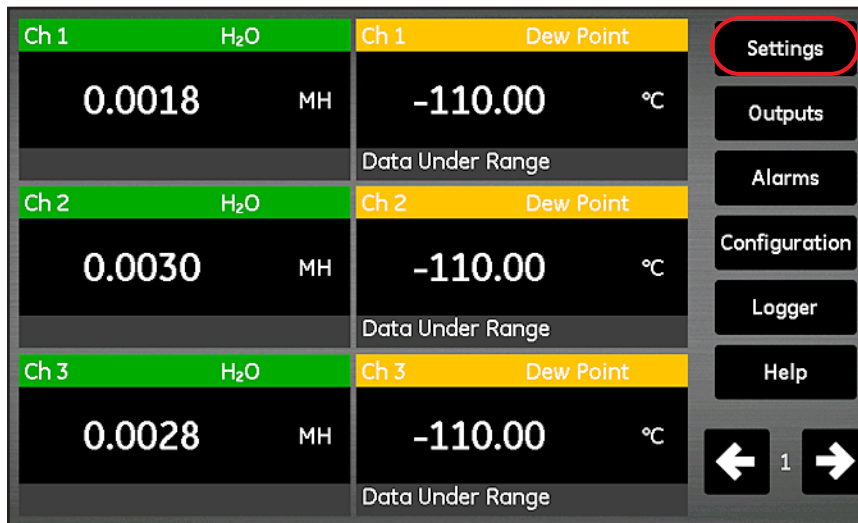

Figure 93: Settings Button on the Main Screen

- In the **Setup** section, tap the **Module** button (see *Figure 94* below).

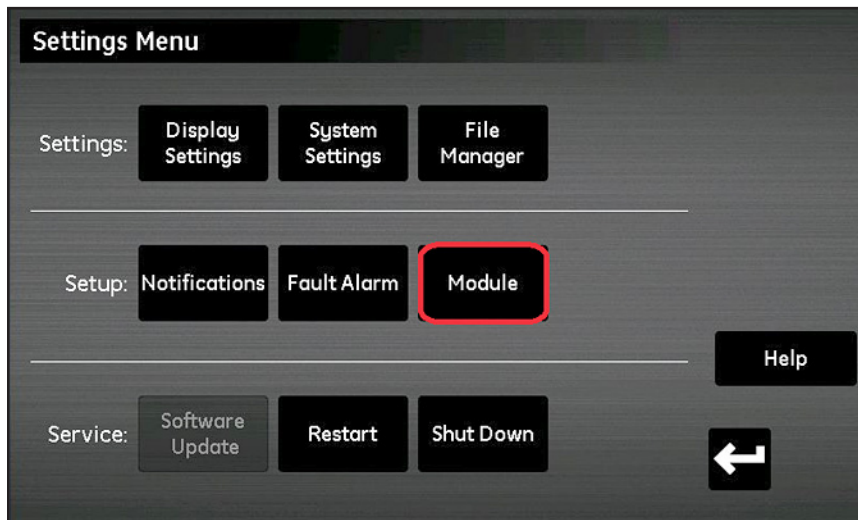

Figure 94: Module Update

## C.2 Updating the moisture.IQ Module Firmware (cont.)

5. Tap the module that needs the firmware update, and that module will be highlighted in blue and the **Update Firmware** button will become available (see *Figure 95* below). If the **Update Firmware** button is grayed out, check to ensure that the USB flash drive is properly plugged into the USB port.

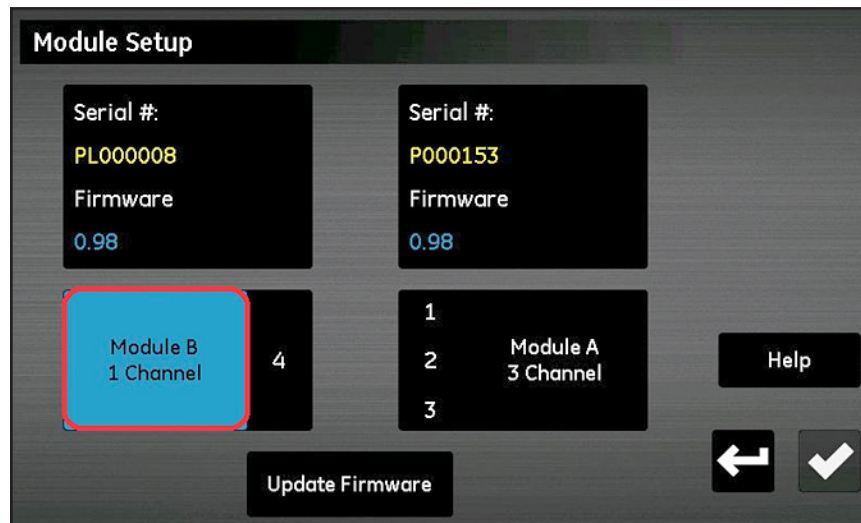

Figure 95: Module Selection

6. Tap the **Update Firmware** button, and the moisture.IQ prompts you to confirm that you want to update the module firmware (see *Figure 96* below). Tap the **Yes** button.

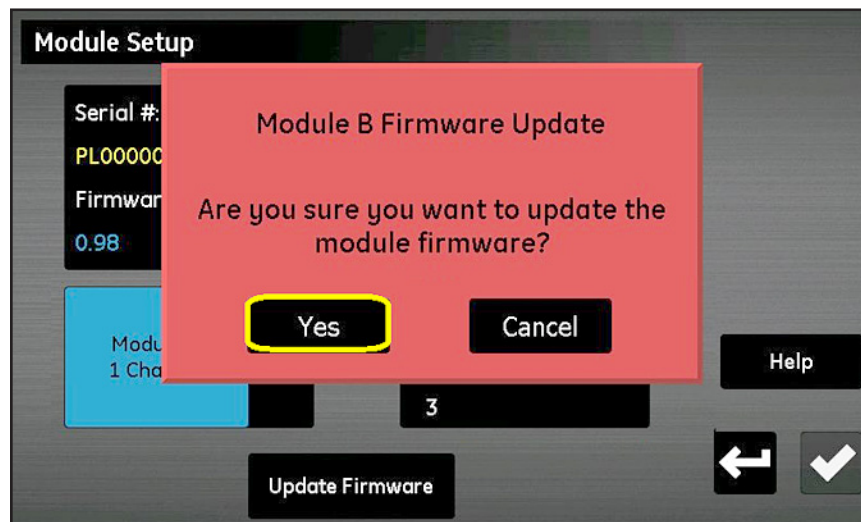

Figure 96: Confirmation Screen

## C.2 Updating the moisture.IQ Module Firmware (cont.)

Updating the software will take a few minutes, and the screen shown in *Figure 97* below is open during the update.



Figure 97: Installing the Firmware

7. After the update is complete (see *Figure 98* below), the meter prompts you to exit. Tap the **Exit** button.

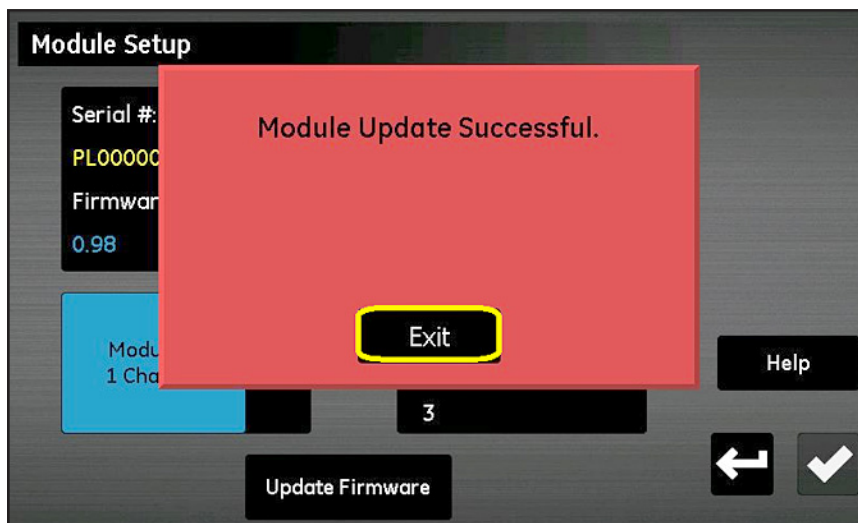
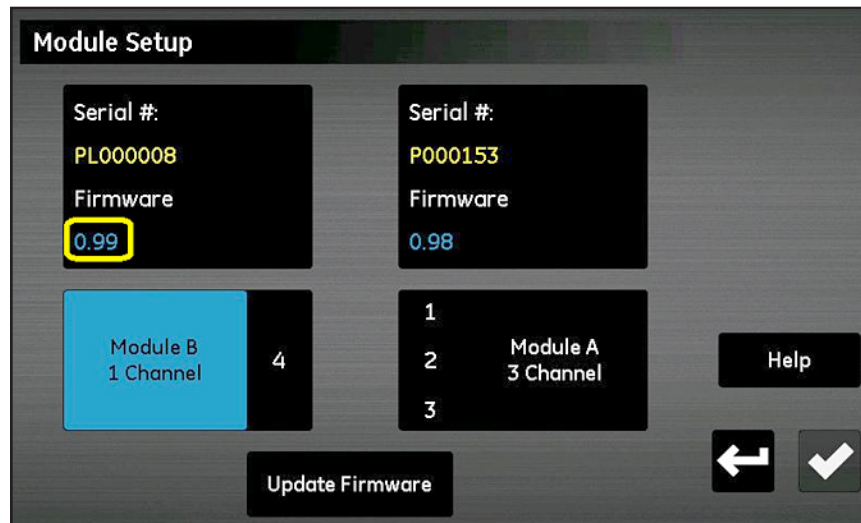

Figure 98: Installation Successful



## C.2 Updating the moisture.IQ Module Firmware (cont.)

The *Module Setup* screen now displays the updated version of the firmware (see *Figure 99* below).



**Figure 99: Module with Updated Firmware**

[no content intended for this page]

## Appendix D. Modbus Register Map

**Note:** The Modbus Register Map in Table 13 below has some fields in gray boxes. These are currently not supported and will return a value of -1.0.

**Table 13: Modbus Register Map**

Function	Parameter	Sub Parameter	ID	Modbus Address	Type	Access	Modbus Request	Qty. of Registers	Notes
0	Error register, non-latching. Read only.		0	0	32-bit Integer	RO	Read Input (0x04)	2	
1000	Latching Error Register		0	1000	32-bit Integer	RW	Read Holding (0x03)	2	Write 0 to clear
2000	Analog Output (4-20)		0						
	Channel 1 / Output A	Output (percent of scale)	100	2112	32-bit float	RW	Read Holding (0x03)	2	When TEST MODE enabled, force output to value
		State	102	2102	32-bit Integer	RW	Read Holding (0x03)	2	2 = TEST MODE All else = run mode
		Units	104	2104	32-bit Integer	RW	Read Holding (0x03)	2	Measurement/Unit Code --- 0 = off, others see tab
		Type	106	2106	32-bit Integer	RW	Read Holding (0x03)	2	1 = 4-20 mA, 2 = 0-20 mA, 3 = 0-2 volts
		Zero	108	2108	32-bit float	RW	Read Holding (0x03)	2	
		Span	110	2110	32-bit float	RW	Read Holding (0x03)	2	
	Channel 1 / Output B	Output (percent of scale)	120	2132	32-bit float	RW	Read Holding (0x03)	2	When TEST MODE enabled, force output to value
		State	122	2122	32-bit Integer	RW	Read Holding (0x03)	2	2 = TEST MODE, All else = run mode
		Units	124	2124	32-bit Integer	RW	Read Holding (0x03)	2	Measurement/Unit Code --- 0 = off, others see tab
		Type	126	2126	32-bit Integer	RW	Read Holding (0x03)	2	1 = 4-20 mA, 2 = 0-20 mA, 3 = 0-2 volts
		Zero	128	2128	32-bit float	RW	Read Holding (0x03)	2	
		Span	130	2130	32-bit float	RW	Read Holding (0x03)	2	

**Table 13: Modbus Register Map (cont.)**

Function	Parameter	Sub Parameter	ID	Modbus Address	Type	Access	Modbus Request	Qty. of Registers	Notes
	Channel 2 / Output A	Output (percent of scale)	200	2212	32-bit float	RW	Read Holding (0x03)	2	When TEST MODE enabled, force output to value
		State	202	2202	32-bit Integer	RW	Read Holding (0x03)	2	2 = TEST MODE, All else = run mode
		Units	204	2204	32-bit Integer	RW	Read Holding (0x03)	2	Measurement/Unit Code 0 = off, others see tab
		Type	206	2206	32-bit Integer	RW	Read Holding (0x03)	2	1 = 4-20 mA, 2 = 0-20 mA, 3 = 0-2 volts
		Zero	208	2208	32-bit float	RW	Read Holding (0x03)	2	
		Span	210	2210	32-bit float	RW	Read Holding (0x03)	2	
	Channel 2 / Output B	Output (percent of scale)	220	2232	32-bit float	RW	Read Holding (0x03)	2	When TEST MODE enabled, force output to value
		State	222	2222	32-bit Integer	RW	Read Holding (0x03)	2	2 = TEST MODE, All else = run mode
		Units	224	2224	32-bit Integer	RW	Read Holding (0x03)	2	Measurement/Unit Code 0 = off, others see tab
		Type	226	2226	32-bit Integer	RW	Read Holding (0x03)	2	1 = 4-20 mA, 2 = 0-20 mA, 3 = 0-2 volts
		Zero	228	2228	32-bit float	RW	Read Holding (0x03)	2	
		Span	230	2230	32-bit float	RW	Read Holding (0x03)	2	
	Channel 3 / Output A	Output (percent of scale)	300	2312	32-bit float	RW	Read Holding (0x03)	2	When TEST MODE enabled, force output to value
		State	302	2302	32-bit Integer	RW	Read Holding (0x03)	2	2 = TEST MODE, All else = run mode
		Units	304	2304	32-bit Integer	RW	Read Holding (0x03)	2	Measurement/Unit Code 0 = off, others see tab
		Type	306	2306	32-bit Integer	RW	Read Holding (0x03)	2	1 = 4-20 mA, 2 = 0-20 mA, 3 = 0-2 volts

**Table 13: Modbus Register Map (cont.)**

Function	Parameter	Sub Parameter	ID	Modbus Address	Type	Access	Modbus Request	Qty. of Registers	Notes
		Zero	308	2308	32-bit float	RW	Read Holding (0x03)	2	
		Span	310	2310	32-bit float	RW	Read Holding (0x03)	2	
	Channel 3 / Output B	Output (percent of scale)	320	2332	32-bit float	RW	Read Holding (0x03)	2	When TEST MODE enabled, force output to value
		State	322	2322	32-bit Integer	RW	Read Holding (0x03)	2	2 = TEST MODE, All else = run mode
		Units	324	2324	32-bit Integer	RW	Read Holding (0x03)	2	Measurement/Unit Code 0 = off, others See tab
		Type	326	2326	32-bit Integer	RW	Read Holding (0x03)	2	1 = 4-20 mA, 2 = 0-20 mA, 3 = 0-2 volts
		Zero	328	2328	32-bit float	RW	Read Holding (0x03)	2	
		Span	330	2330	32-bit float	RW	Read Holding (0x03)	2	
	Channel 4 / Output A	Output (percent of scale)	400	2412	32-bit float	RW	Read Holding (0x03)	2	When TEST MODE enabled, force output to value
		State	402	2402	32-bit Integer	RW	Read Holding (0x03)	2	2 = TEST MODE, All else = run mode
		Units	404	2404	32-bit Integer	RW	Read Holding (0x03)	2	Measurement/Unit Code 0 = off, others see tab
		Type	406	2406	32-bit Integer	RW	Read Holding (0x03)	2	1 = 4-20 mA, 2 = 0-20 mA, 3 = 0-2 volts
		Zero	408	2408	32-bit float	RW	Read Holding (0x03)	2	
		Span	410	2410	32-bit float	RW	Read Holding (0x03)	2	
	Channel 4 / Output B	Output (percent of scale)	420	2432	32-bit float	RW	Read Holding (0x03)	2	When TEST MODE enabled, force output to value
		State	422	2422	32-bit Integer	RW	Read Holding (0x03)	2	2 = TEST MODE, All else = run mode

**Table 13: Modbus Register Map (cont.)**

Function	Parameter	Sub Parameter	ID	Modbus Address	Type	Access	Modbus Request	Qty. of Registers	Notes
		Units	424	2424	32-bit Integer	RW	Read Holding (0x03)	2	Measurement/Unit Code 0 = off, others see tab
		Type	426	2426	32-bit Integer	RW	Read Holding (0x03)	2	1 = 4-20 mA, 2 = 0-20 mA, 3 = 0-2 volts
		Zero	428	2428	32-bit float	RW	Read Holding (0x03)	2	
		Span	430	2430	32-bit float	RW	Read Holding (0x03)	2	
	Channel 5 / Output A	Output (percent of scale)	500	2512	32-bit float	RW	Read Holding (0x03)	2	When TEST MODE enabled, force output to value
		State	502	2502	32-bit Integer	RW	Read Holding (0x03)	2	2 = TEST MODE, All else = run mode
		Units	504	2504	32-bit Integer	RW	Read Holding (0x03)	2	Measurement/Unit Code 0 = off, others see tab
		Type	506	2506	32-bit Integer	RW	Read Holding (0x03)	2	1 = 4-20 mA, 2 = 0-20 mA, 3 = 0-2 volts
		Zero	508	2508	32-bit float	RW	Read Holding (0x03)	2	
		Span	510	2510	32-bit float	RW	Read Holding (0x03)	2	
	Channel 5 / Output B	Output (percent of scale)	520	2532	32-bit float	RW	Read Holding (0x03)	2	When TEST MODE enabled, force output to value
		State	522	2522	32-bit Integer	RW	Read Holding (0x03)	2	2 = TEST MODE, All else = run mode
		Units	524	2524	32-bit Integer	RW	Read Holding (0x03)	2	Measurement/Unit Code 0 = off, others see tab
		Type	526	2526	32-bit Integer	RW	Read Holding (0x03)	2	1 = 4-20 mA, 2 = 0-20 mA, 3 = 0-2 volts
		Zero	528	2528	32-bit float	RW	Read Holding (0x03)	2	
		Span	530	2530	32-bit float	RW	Read Holding (0x03)	2	

**Table 13: Modbus Register Map (cont.)**

Function	Parameter	Sub Parameter	ID	Modbus Address	Type	Access	Modbus Request	Qty. of Registers	Notes
	Channel 6 / Output A	Output (percent of scale)	600	2612	32-bit float	RW	Read Holding (0x03)	2	When TEST MODE enabled, force output to value
		State	602	2602	32-bit Integer	RW	Read Holding (0x03)	2	2 = TEST MODE, All else = run mode
		Units	604	2604	32-bit Integer	RW	Read Holding (0x03)	2	Measurement/Unit Code 0 = off, others See tab
		Type	606	2606	32-bit Integer	RW	Read Holding (0x03)	2	1 = 4-20 mA, 2 = 0-20 mA, 3 = 0-2 volts
		Zero	608	2608	32-bit float	RW	Read Holding (0x03)	2	
		Span	610	2610	32-bit float	RW	Read Holding (0x03)	2	
	Channel 6 / Output B	Output (percent of scale)	620	2632	32-bit float	RW	Read Holding (0x03)	2	When TEST MODE enabled, force output to value
		State	622	2622	32-bit Integer	RW	Read Holding (0x03)	2	2 = TEST MODE, All else = run mode
		Units	624	2624	32-bit Integer	RW	Read Holding (0x03)	2	Measurement/Unit Code 0 = off, others see tab
		Type	626	2626	32-bit Integer	RW	Read Holding (0x03)	2	1 = 4-20 mA, 2 = 0-20 mA, 3 = 0-2 volts
		Zero	628	2628	32-bit float	RW	Read Holding (0x03)	2	
		Span	630	2630	32-bit float	RW	Read Holding (0x03)	2	
3000	All Alarm Status		0	3012	32-bit Integer	RO	Read Input (0x04)	2	Bit wise Alarm Status. 1 = Energized 0 = De-energized
	Channel 1 / Alarm A	Status	100	3100	32-bit Integer	RO	Read Input (0x04)	2	1 = Energized 0 = De-energized
		State	102	3102	32-bit Integer	RO	Read Holding (0x04)	2	0 = Disabled, 1 = Enabled
		Units	104	3104	32-bit Integer	RW	Read Holding (0x03)	2	Measurement/Unit Code 0 = off, others see tab

**Table 13: Modbus Register Map (cont.)**

Function	Parameter	Sub Parameter	ID	Modbus Address	Type	Access	Modbus Request	Qty. of Registers	Notes
		Type	106	3106	32-bit Integer	RW	Read Holding (0x03)	2	1 = Setpoint, 2 = In Band, 3 = Out Band
		Lower Setpoint	108	3108	32-bit float	RW	Read Holding (0x03), Write Multiple (0x10)	2	
		Upper Setpoint	110	3110	32-bit float	RW	Read Holding (0x03), Write Multiple (0x10)	2	
	Channel 1 / Alarm B	Status	120	3120	32-bit Integer	RO	Read Input (0x04)	2	1 = Energized 0 = De-energized
		State	122	3122	32-bit Integer	RO	Read Holding (0x04)	2	0 = Disabled, 1 = Enabled
		Units	124	3124	32-bit Integer	RW	Read Holding (0x03)	2	Measurement/Unit Code 0 = off, others see tab
		Type	126	3126	32-bit Integer	RW	Read Holding (0x03)	2	1 = Setpoint, 2 = In Band, 3 = Out Band
		Lower Setpoint	128	3128	32-bit float	RW	Read Holding (0x03), Write Multiple (0x10)	2	
		Upper Setpoint	130	3130	32-bit float	RW	Read Holding (0x03), Write Multiple (0x10)	2	
	Channel 2 / Alarm A	Status	200	3200	32-bit Integer	RO	Read Input (0x04)	2	1 = Energized 0 = De-energized
		State	202	3202	32-bit Integer	RO	Read Holding (0x04)	2	0 = Disabled, 1 = Enabled
		Units	204	3204	32-bit Integer	RW	Read Holding (0x03)	2	Measurement/Unit Code --- 0 = off/others See tab
		Type	206	3206	32-bit Integer	RW	Read Holding (0x03)	2	1 = Setpoint, 2 = In Band, 3 = Out Band



**Table 13: Modbus Register Map (cont.)**

Function	Parameter	Sub Parameter	ID	Modbus Address	Type	Access	Modbus Request	Qty. of Registers	Notes
		Lower Setpoint	208	3208	32-bit float	RW	Read Holding (0x03), Write Multiple (0x10)	2	
		Upper Setpoint	210	3210	32-bit float	RW	Read Holding (0x03), Write Multiple (0x10)	2	
	Channel 2 / Alarm B	Status	220	3220	32-bit Integer	RO	Read Input (0x04)	2	1 = Energized 0 = De-energized
		State	222	3222	32-bit Integer	RO	Read Holding (0x04)	2	0 = Disabled, 1 = Enabled
		Units	224	3224	32-bit Integer	RW	Read Holding (0x03)	2	Measurement/Unit Code 0 = off, others see tab
		Type	226	3226	32-bit Integer	RW	Read Holding (0x03)	2	1 = Setpoint, 2 = In Band, 3 = Out Band
		Lower Setpoint	228	3228	32-bit float	RW	Read Holding (0x03), Write Multiple (0x10)	2	
		Upper Setpoint	230	3230	32-bit float	RW	Read Holding (0x03), Write Multiple (0x10)	2	
	Channel 3 / Alarm A	Status	300	3300	32-bit Integer	RO	Read Input (0x04)	2	1 = Energized 0 = De-energized
		State	302	3302	32-bit Integer	RO	Read Holding (0x04)	2	0 = Disabled, 1 = Enabled
		Units	304	3304	32-bit Integer	RW	Read Holding (0x03)	2	Measurement/Unit Code 0 = off, others see tab
		Type	306	3306	32-bit Integer	RW	Read Holding (0x03)	2	1 = Setpoint, 2 = In Band, 3 = Out Band

**Table 13: Modbus Register Map (cont.)**

Function	Parameter	Sub Parameter	ID	Modbus Address	Type	Access	Modbus Request	Qty. of Registers	Notes
		Lower Setpoint	308	3308	32-bit float	RW	Read Holding (0x03), Write Multiple (0x10)	2	
		Upper Setpoint	310	3310	32-bit float	RW	Read Holding (0x03), Write Multiple (0x10)	2	
	Channel 3 / Alarm B	Status	320	3320	32-bit Integer	RO	Read Input (0x04)	2	1 = Energized 0 = De-energized
		State	322	3322	32-bit Integer	RO	Read Holding (0x04)	2	0 = Disabled, 1 = Enabled
		Units	324	3324	32-bit Integer	RW	Read Holding (0x03)	2	Measurement/Unit Code 0 = off, others see tab
		Type	326	3326	32-bit Integer	RW	Read Holding (0x03)	2	1 = Setpoint, 2 = In Band, 3 = Out Band
		Lower Setpoint	328	3328	32-bit float	RW	Read Holding (0x03), Write Multiple (0x10)	2	
		Upper Setpoint	330	3330	32-bit float	RW	Read Holding (0x03), Write Multiple (0x10)	2	
	Channel 4 / Alarm A	Status	400	3400	32-bit Integer	RO	Read Input (0x04)	2	1 = Energized 0 = De-energized
		State	402	3402	32-bit Integer	RO	Read Holding (0x04)	2	0 = Disabled, 1 = Enabled
		Units	404	3404	32-bit Integer	RW	Read Holding (0x03)	2	Measurement/Unit Code 0 = off, others see tab
		Type	406	3406	32-bit Integer	RW	Read Holding (0x03)	2	1 = Setpoint, 2 = In Band, 3 = Out Band

**Table 13: Modbus Register Map (cont.)**

Function	Parameter	Sub Parameter	ID	Modbus Address	Type	Access	Modbus Request	Qty. of Registers	Notes
		Lower Setpoint	408	3408	32-bit float	RW	Read Holding (0x03), Write Multiple (0x10)	2	
		Upper Setpoint	410	3410	32-bit float	RW	Read Holding (0x03), Write Multiple (0x10)	2	
	Channel 4 / Alarm B	Status	420	3420	32-bit Integer	RO	Read Input (0x04)	2	1 = Energized 0 = De-energized
		State	422	3422	32-bit Integer	RO	Read Holding (0x04)	2	0 = Disabled, 1 = Enabled
		Units	424	3424	32-bit Integer	RW	Read Holding (0x03)	2	Measurement/Unit Code 0 = off, others see tab
		Type	426	3426	32-bit Integer	RW	Read Holding (0x03)	2	1 = Setpoint, 2 = In Band, 3 = Out Band
		Lower Setpoint	428	3428	32-bit float	RW	Read Holding (0x03), Write Multiple (0x10)	2	
		Upper Setpoint	430	3430	32-bit float	RW	Read Holding (0x03), Write Multiple (0x10)	2	
	Channel 5 / Alarm A	Status	500	3500	32-bit Integer	RO	Read Input (0x04)	2	1 = Energized 0 = De-energized
		State	502	3502	32-bit Integer	RO	Read Holding (0x04)	2	0 = Disabled, 1 = Enabled
		Units	504	3504	32-bit Integer	RW	Read Holding (0x03)	2	Measurement/Unit Code 0 = off, others see tab
		Type	506	3506	32-bit Integer	RW	Read Holding (0x03)	2	1 = Setpoint, 2 = In Band, 3 = Out Band

**Table 13: Modbus Register Map (cont.)**

Function	Parameter	Sub Parameter	ID	Modbus Address	Type	Access	Modbus Request	Qty. of Registers	Notes
		Lower Setpoint	508	3508	32-bit float	RW	Read Holding (0x03), Write Multiple (0x10)	2	
		Upper Setpoint	510	3510	32-bit float	RW	Read Holding (0x03), Write Multiple (0x10)	2	
	Channel 5 / Alarm B	Status	520	3520	32-bit Integer	RO	Read Input (0x04)	2	1 = Energized 0 = De-energized
		State	522	3522	32-bit Integer	RO	Read Holding (0x04)	2	0 = Disabled, 1 = Enabled
		Units	524	3524	32-bit Integer	RW	Read Holding (0x03)	2	Measurement/Unit Code 0 = off, others see tab
		Type	526	3526	32-bit Integer	RW	Read Holding (0x03)	2	1 = Setpoint, 2 = In Band, 3 = Out Band
		Lower Setpoint	528	3528	32-bit float	RW	Read Holding (0x03), Write Multiple (0x10)	2	
		Upper Setpoint	530	3530	32-bit float	RW	Read Holding (0x03), Write Multiple (0x10)	2	
	Channel 6 / Alarm A	Status	600	3600	32-bit Integer	RO	Read Input (0x04)	2	1 = Energized 0 = De-energized
		State	602	3602	32-bit Integer	RO	Read Holding (0x04)	2	0 = Disabled, 1 = Enabled
		Units	604	3604	32-bit Integer	RW	Read Holding (0x03)	2	Measurement/Unit Code 0 = off, others see tab
		Type	606	3606	32-bit Integer	RW	Read Holding (0x03)	2	1 = Setpoint, 2 = In Band, 3 = Out Band

**Table 13: Modbus Register Map (cont.)**

Function	Parameter	Sub Parameter	ID	Modbus Address	Type	Access	Modbus Request	Qty. of Registers	Notes
		Lower Setpoint	608	3608	32-bit float	RW	Read Holding (0x03), Write Multiple (0x10)	2	
		Upper Setpoint	610	3610	32-bit float	RW	Read Holding (0x03), Write Multiple (0x10)	2	
	Channel 6 / Alarm B	Status	620	3620	32-bit Integer	RO	Read Input (0x04)	2	1 = Energized 0 = De-energized
		State	622	3622	32-bit Integer	RO	Read Holding (0x04)	2	0 = Disabled, 1 = Enabled
		Units	624	3624	32-bit Integer	RW	Read Holding (0x03)	2	Measurement/Unit Code 0 = off, others see tab
		Type	626	3626	32-bit Integer	RW	Read Holding (0x03)	2	1 = Setpoint, 2 = In Band, 3 = Out Band
		Lower Setpoint	628	3628	32-bit float	RW	Read Holding (0x03), Write Multiple (0x10)	2	
		Upper Setpoint	630	3630	32-bit float	RW	Read Holding (0x03), Write Multiple (0x10)	2	
5000	Block Measurement Read								
		Block Read Measurements	0	5000	32-bit float		Read Input (0x04)	2-32	Returns 1-16 measurements
		Block Read Unit Codes	0	5000	32-bit Integer		Read Holding (0x03)	2-32	Returns 1-16 Unit Codes
		Block Write Unit Codes	0	5000	32-bit Integer		Write Multiple (0x10)	2-32	Set Unit Codes for Measurements 0-15
5100	Single Measurement Read								

**Table 13: Modbus Register Map (cont.)**

Function	Parameter	Sub Parameter	ID	Modbus Address	Type	Access	Modbus Request	Qty. of Registers	Notes
	Channel 1	Hygro - Dew Point °C	2	5102	32-bit float	RO	Read Input (0x04)	2	
		Hygro - Dew Point °F	4	5104	32-bit float	RO	Read Input (0x04)	2	
		Hygro - Equiv. Dew Point °C	6	5106	32-bit float	RO	Read Input (0x04)	2	
		Hygro - Equiv. Dew Point °F	8	5108	32-bit float	RO	Read Input (0x04)	2	
		Hygro - PPMv	10	5110	32-bit float	RO	Read Input (0x04)	2	
		Hygro - PPBv	12	5112	32-bit float	RO	Read Input (0x04)	2	
		Hygro - PPMw	14	5114	32-bit float	RO	Read Input (0x04)	2	
		Hygro - RH %	16	5116	32-bit float	RO	Read Input (0x04)	2	
		Hygro - Lbs/MMSCF (ideal gas)	18	5118	32-bit float	RO	Read Input (0x04)	2	
		Hygro - Lbs/MMSCF (natural gas)	20	5120	32-bit float	RO	Read Input (0x04)	2	
		Hygro - PPMv (natural gas)	22	5122	32-bit float	RO	Read Input (0x04)	2	
		Hygro - g/m <sup>3</sup>	24	5124	32-bit float	RO	Read Input (0x04)	2	
		Hygro - mg/m <sup>3</sup>	26	5126	32-bit float	RO	Read Input (0x04)	2	
		Hygro - Vapor Pressure (kPa)	28	5128	32-bit float	RO	Read Input (0x04)	2	
		Hygro - Vapor Pressure (mm Hg)	30	5130	32-bit float	RO	Read Input (0x04)	2	
		Hygro - MH / FH	32	5132	32-bit float	RO	Read Input (0x04)	2	
		Temperature - °C	34	5134	32-bit float	RO	Read Input (0x04)	2	
		Temperature - °F	36	5136	32-bit float	RO	Read Input (0x04)	2	
		Temperature - Kelvin	38	5138	32-bit float	RO	Read Input (0x04)	2	
		Temperature - Rankine	40	5140	32-bit float	RO	Read Input (0x04)	2	
		Pressure - kPa -gauge	42	5142	32-bit float	RO	Read Input (0x04)	2	
		Pressure - Mpa - gauge	44	5144	32-bit float	RO	Read Input (0x04)	2	

**Table 13: Modbus Register Map (cont.)**

Function	Parameter	Sub Parameter	ID	Modbus Address	Type	Access	Modbus Request	Qty. of Registers	Notes
		Pressure - Pa-gauge	46	5146	32-bit float	RO	Read Input (0x04)	2	
		Pressure - Bar-gauge	48	5148	32-bit float	RO	Read Input (0x04)	2	
		Pressure - kPa-absolute	50	5150	32-bit float	RO	Read Input (0x04)	2	
		Pressure - MPa-absolute	52	5152	32-bit float	RO	Read Input (0x04)	2	
		Pressure - Pa-absolute	54	5154	32-bit float	RO	Read Input (0x04)	2	
		Pressure - Bar-absolute	56	5156	32-bit float	RO	Read Input (0x04)	2	
		Pressure - Atm	58	5158	32-bit float	RO	Read Input (0x04)	2	
		Pressure - PSla	60	5160	32-bit float	RO	Read Input (0x04)	2	
		Pressure - PSlg	62	5162	32-bit float	RO	Read Input (0x04)	2	
		Pressure - mm Hg	64	5164	32-bit float	RO	Read Input (0x04)	2	
		Pressure - FP	66	5166	32-bit float	RO	Read Input (0x04)	2	
		Oxygen - PPM	70	5170	32-bit float	RO	Read Input (0x04)	2	
		Oxygen - PPB	72	5172	32-bit float	RO	Read Input (0x04)	2	
		Oxygen - Percent	74	5174	32-bit float	RO	Read Input (0x04)	2	
		Oxygen - $\mu$ A	76	5176	32-bit float	RO	Read Input (0x04)	2	
		Aux A	80	5180	32-bit float	RO	Read Input (0x04)	2	
		Aux A scaled	82	5182	32-bit float	RO	Read Input (0x04)	2	
		Aux B	84	5184	32-bit float	RO	Read Input (0x04)	2	
		Aux B scaled	86	5186	32-bit float	RO	Read Input (0x04)	2	
		User Function 1	90	5190	32-bit float	RO	Read Input (0x04)	2	
		User Function 2	92	5192	32-bit float	RO	Read Input (0x04)	2	
		User Function 3	94	5194	32-bit float	RO	Read Input (0x04)	2	
		User Function 4	96	5196	32-bit float	RO	Read Input (0x04)	2	
	Channel 2	Hygro - Dew Point $^{\circ}$ C	102	5202	32-bit float	RO	Read Input (0x04)	2	

**Table 13: Modbus Register Map (cont.)**

Function	Parameter	Sub Parameter	ID	Modbus Address	Type	Access	Modbus Request	Qty. of Registers	Notes
		Hygro - Dew Point °F	104	5204	32-bit float	RO	Read Input (0x04)	2	
		Hygro - Equiv. Dew Point °C	106	5206	32-bit float	RO	Read Input (0x04)	2	
		Hygro - Equiv. Dew Point °F	108	5208	32-bit float	RO	Read Input (0x04)	2	
		Hygro - PPMv	110	5210	32-bit float	RO	Read Input (0x04)	2	
		Hygro - PPBv	112	5212	32-bit float	RO	Read Input (0x04)	2	
		Hygro - PPMw	114	5214	32-bit float	RO	Read Input (0x04)	2	
		Hygro - RH %	116	5216	32-bit float	RO	Read Input (0x04)	2	
		Hygro - Lbs/MMSCF (ideal gas)	118	5218	32-bit float	RO	Read Input (0x04)	2	
		Hygro - Lbs/MMSCF (natural gas)	120	5220	32-bit float	RO	Read Input (0x04)	2	
		Hygro - PPMv (natural gas)	122	5222	32-bit float	RO	Read Input (0x04)	2	
		Hygro - g/m <sup>3</sup>	124	5224	32-bit float	RO	Read Input (0x04)	2	
		Hygro - mg/m <sup>3</sup>	126	5226	32-bit float	RO	Read Input (0x04)	2	
		Hygro - Vapor Pressure (kPa)	128	5228	32-bit float	RO	Read Input (0x04)	2	
		Hygro - Vapor Pressure (mm Hg)	130	5230	32-bit float	RO	Read Input (0x04)	2	
		Hygro - MH / FH	132	5232	32-bit float	RO	Read Input (0x04)	2	
		Temperature - °C	134	5234	32-bit float	RO	Read Input (0x04)	2	
		Temperature - °F	136	5236	32-bit float	RO	Read Input (0x04)	2	
		Temperature - Kelvin	138	5238	32-bit float	RO	Read Input (0x04)	2	
		Temperature - Rankine	140	5240	32-bit float	RO	Read Input (0x04)	2	
		Pressure - kPa -gauge	142	5242	32-bit float	RO	Read Input (0x04)	2	
		Pressure - Mpa - gauge	144	5244	32-bit float	RO	Read Input (0x04)	2	
		Pressure - Pa -gauge	146	5246	32-bit float	RO	Read Input (0x04)	2	



**Table 13: Modbus Register Map (cont.)**

Function	Parameter	Sub Parameter	ID	Modbus Address	Type	Access	Modbus Request	Qty. of Registers	Notes
		Pressure - Bar-gauge	148	5248	32-bit float	RO	Read Input (0x04)	2	
		Pressure - kPa-absolute	150	5250	32-bit float	RO	Read Input (0x04)	2	
		Pressure - MPa-absolute	152	5252	32-bit float	RO	Read Input (0x04)	2	
		Pressure - Pa-absolute	154	5254	32-bit float	RO	Read Input (0x04)	2	
		Pressure - Bar-absolute	156	5256	32-bit float	RO	Read Input (0x04)	2	
		Pressure - Atm	158	5258	32-bit float	RO	Read Input (0x04)	2	
		Pressure - PSia	160	5260	32-bit float	RO	Read Input (0x04)	2	
		Pressure - PSig	162	5262	32-bit float	RO	Read Input (0x04)	2	
		Pressure - mm Hg	164	5264	32-bit float	RO	Read Input (0x04)	2	
		Pressure - FP	166	5266	32-bit float	RO	Read Input (0x04)	2	
		Oxygen - PPM	170	5270	32-bit float	RO	Read Input (0x04)	2	
		Oxygen - PPB	172	5272	32-bit float	RO	Read Input (0x04)	2	
		Oxygen - Percent	174	5274	32-bit float	RO	Read Input (0x04)	2	
		Oxygen - $\mu$ A	176	5276	32-bit float	RO	Read Input (0x04)	2	
		Aux A	180	5280	32-bit float	RO	Read Input (0x04)	2	
		Aux A scaled	182	5282	32-bit float	RO	Read Input (0x04)	2	
		Aux B	184	5284	32-bit float	RO	Read Input (0x04)	2	
		Aux B scaled	186	5286	32-bit float	RO	Read Input (0x04)	2	
		User Function 1	190	5290	32-bit float	RO	Read Input (0x04)	2	
		User Function 2	192	5292	32-bit float	RO	Read Input (0x04)	2	
		User Function 3	194	5294	32-bit float	RO	Read Input (0x04)	2	
		User Function 4	196	5296	32-bit float	RO	Read Input (0x04)	2	
	Channel 3	Hygro - Dew Point °C	202	5302	32-bit float	RO	Read Input (0x04)	2	
		Hygro - Dew Point °F	204	5304	32-bit float	RO	Read Input (0x04)	2	

**Table 13: Modbus Register Map (cont.)**

Function	Parameter	Sub Parameter	ID	Modbus Address	Type	Access	Modbus Request	Qty. of Registers	Notes
		Hygro - Equiv. Dew Point °C	206	5306	32-bit float	RO	Read Input (0x04)	2	
		Hygro - Equiv. Dew Point °F	208	5308	32-bit float	RO	Read Input (0x04)	2	
		Hygro - PPMv	210	5310	32-bit float	RO	Read Input (0x04)	2	
		Hygro - PPBv	212	5312	32-bit float	RO	Read Input (0x04)	2	
		Hygro - PPMw	214	5314	32-bit float	RO	Read Input (0x04)	2	
		Hygro - RH %	216	5316	32-bit float	RO	Read Input (0x04)	2	
		Hygro - Lbs/MMSCF (ideal gas)	218	5318	32-bit float	RO	Read Input (0x04)	2	
		Hygro - Lbs/MMSCF (natural gas)	220	5320	32-bit float	RO	Read Input (0x04)	2	
		Hygro - PPMv (natural gas)	222	5322	32-bit float	RO	Read Input (0x04)	2	
		Hygro - g/m <sup>3</sup>	224	5324	32-bit float	RO	Read Input (0x04)	2	
		Hygro - mg/m <sup>3</sup>	226	5326	32-bit float	RO	Read Input (0x04)	2	
		Hygro - Vapor Pressure (kPa)	228	5328	32-bit float	RO	Read Input (0x04)	2	
		Hygro - Vapor Pressure (mm Hg)	230	5330	32-bit float	RO	Read Input (0x04)	2	
		Hygro - MH / FH	232	5332	32-bit float	RO	Read Input (0x04)	2	
		Temperature - °C	234	5334	32-bit float	RO	Read Input (0x04)	2	
		Temperature - °F	236	5336	32-bit float	RO	Read Input (0x04)	2	
		Temperature - Kelvin	238	5338	32-bit float	RO	Read Input (0x04)	2	
		Temperature - Rankine	240	5340	32-bit float	RO	Read Input (0x04)	2	
		Pressure - kPa -gauge	242	5342	32-bit float	RO	Read Input (0x04)	2	
		Pressure - Mpa - gauge	244	5344	32-bit float	RO	Read Input (0x04)	2	
		Pressure - Pa -gauge	246	5346	32-bit float	RO	Read Input (0x04)	2	
		Pressure - Bar -gauge	248	5348	32-bit float	RO	Read Input (0x04)	2	

**Table 13: Modbus Register Map (cont.)**

Function	Parameter	Sub Parameter	ID	Modbus Address	Type	Access	Modbus Request	Qty. of Registers	Notes
		Pressure - kPa -absolute	250	5350	32-bit float	RO	Read Input (0x04)	2	
		Pressure - MPa -absolute	252	5352	32-bit float	RO	Read Input (0x04)	2	
		Pressure - Pa -absolute	254	5354	32-bit float	RO	Read Input (0x04)	2	
		Pressure - Bar -absolute	256	5356	32-bit float	RO	Read Input (0x04)	2	
		Pressure - Atm	258	5358	32-bit float	RO	Read Input (0x04)	2	
		Pressure - PSia	260	5360	32-bit float	RO	Read Input (0x04)	2	
		Pressure - PSig	262	5362	32-bit float	RO	Read Input (0x04)	2	
		Pressure - mm Hg	264	5364	32-bit float	RO	Read Input (0x04)	2	
		Pressure - FP	266	5366	32-bit float	RO	Read Input (0x04)	2	
		Oxygen - PPM	270	5370	32-bit float	RO	Read Input (0x04)	2	
		Oxygen - PPB	272	5372	32-bit float	RO	Read Input (0x04)	2	
		Oxygen - Percent	274	5374	32-bit float	RO	Read Input (0x04)	2	
		Oxygen - $\mu$ A	276	5376	32-bit float	RO	Read Input (0x04)	2	
		Aux A	280	5380	32-bit float	RO	Read Input (0x04)	2	
		Aux A scaled	282	5382	32-bit float	RO	Read Input (0x04)	2	
		Aux B	284	5384	32-bit float	RO	Read Input (0x04)	2	
		Aux B scaled	286	5386	32-bit float	RO	Read Input (0x04)	2	
		User Function 1	290	5390	32-bit float	RO	Read Input (0x04)	2	
		User Function 2	292	5392	32-bit float	RO	Read Input (0x04)	2	
		User Function 3	294	5394	32-bit float	RO	Read Input (0x04)	2	
		User Function 4	296	5396	32-bit float	RO	Read Input (0x04)	2	
	Channel 4	Hygro - Dew Point °C	302	5402	32-bit float	RO	Read Input (0x04)	2	
		Hygro - Dew Point °F	304	5404	32-bit float	RO	Read Input (0x04)	2	
		Hygro - Equiv. Dew Point °C	306	5406	32-bit float	RO	Read Input (0x04)	2	

**Table 13: Modbus Register Map (cont.)**

Function	Parameter	Sub Parameter	ID	Modbus Address	Type	Access	Modbus Request	Qty. of Registers	Notes
		Hygro - Equiv. Dew Point °F	308	5408	32-bit float	RO	Read Input (0x04)	2	
		Hygro - PPMv	310	5410	32-bit float	RO	Read Input (0x04)	2	
		Hygro - PPBv	312	5412	32-bit float	RO	Read Input (0x04)	2	
		Hygro - PPMw	314	5414	32-bit float	RO	Read Input (0x04)	2	
		Hygro - RH %	316	5416	32-bit float	RO	Read Input (0x04)	2	
		Hygro - Lbs/MMSCF (ideal gas)	318	5418	32-bit float	RO	Read Input (0x04)	2	
		Hygro - Lbs/MMSCF (natural gas)	320	5420	32-bit float	RO	Read Input (0x04)	2	
		Hygro - PPMv (natural gas)	322	5422	32-bit float	RO	Read Input (0x04)	2	
		Hygro - g/m <sup>3</sup>	324	5424	32-bit float	RO	Read Input (0x04)	2	
		Hygro - mg/m <sup>3</sup>	326	5426	32-bit float	RO	Read Input (0x04)	2	
		Hygro - Vapor Pressure (kPa)	328	5428	32-bit float	RO	Read Input (0x04)	2	
		Hygro - Vapor Pressure (mm Hg)	330	5430	32-bit float	RO	Read Input (0x04)	2	
		Hygro - MH / FH	332	5432	32-bit float	RO	Read Input (0x04)	2	
		Temperature - °C	334	5434	32-bit float	RO	Read Input (0x04)	2	
		Temperature - °F	336	5436	32-bit float	RO	Read Input (0x04)	2	
		Temperature - Kelvin	338	5438	32-bit float	RO	Read Input (0x04)	2	
		Temperature - Rankine	340	5440	32-bit float	RO	Read Input (0x04)	2	
		Pressure - kPa -gauge	342	5442	32-bit float	RO	Read Input (0x04)	2	
		Pressure - Mpa - gauge	344	5444	32-bit float	RO	Read Input (0x04)	2	
		Pressure - Pa -gauge	346	5446	32-bit float	RO	Read Input (0x04)	2	
		Pressure - Bar -gauge	348	5448	32-bit float	RO	Read Input (0x04)	2	

**Table 13: Modbus Register Map (cont.)**

Function	Parameter	Sub Parameter	ID	Modbus Address	Type	Access	Modbus Request	Qty. of Registers	Notes
		Pressure - kPa -absolute	350	5450	32-bit float	RO	Read Input (0x04)	2	
		Pressure - MPa -absolute	352	5452	32-bit float	RO	Read Input (0x04)	2	
		Pressure - Pa -absolute	354	5454	32-bit float	RO	Read Input (0x04)	2	
		Pressure - Bar -absolute	356	5456	32-bit float	RO	Read Input (0x04)	2	
		Pressure - Atm	358	5458	32-bit float	RO	Read Input (0x04)	2	
		Pressure - PSia	360	5460	32-bit float	RO	Read Input (0x04)	2	
		Pressure - PSig	362	5462	32-bit float	RO	Read Input (0x04)	2	
		Pressure - mm Hg	364	5464	32-bit float	RO	Read Input (0x04)	2	
		Pressure - FP	366	5466	32-bit float	RO	Read Input (0x04)	2	
		Oxygen - PPM	370	5470	32-bit float	RO	Read Input (0x04)	2	
		Oxygen - PPB	372	5472	32-bit float	RO	Read Input (0x04)	2	
		Oxygen - Percent	374	5474	32-bit float	RO	Read Input (0x04)	2	
		Oxygen - $\mu$ A	376	5476	32-bit float	RO	Read Input (0x04)	2	
		Aux A	380	5480	32-bit float	RO	Read Input (0x04)	2	
		Aux A scaled	382	5482	32-bit float	RO	Read Input (0x04)	2	
		Aux B	384	5484	32-bit float	RO	Read Input (0x04)	2	
		Aux B scaled	386	5486	32-bit float	RO	Read Input (0x04)	2	
		User Function 1	390	5490	32-bit float	RO	Read Input (0x04)	2	
		User Function 2	392	5492	32-bit float	RO	Read Input (0x04)	2	
		User Function 3	394	5494	32-bit float	RO	Read Input (0x04)	2	
		User Function 4	396	5496	32-bit float	RO	Read Input (0x04)	2	
	Channel 5	Hygro - Dew Point °C	402	5502	32-bit float	RO	Read Input (0x04)	2	
		Hygro - Dew Point °F	404	5504	32-bit float	RO	Read Input (0x04)	2	
		Hygro - Equiv. Dew Point °C	406	5506	32-bit float	RO	Read Input (0x04)	2	

**Table 13: Modbus Register Map (cont.)**

Function	Parameter	Sub Parameter	ID	Modbus Address	Type	Access	Modbus Request	Qty. of Registers	Notes
		Hygro - Equiv. Dew Point °F	408	5508	32-bit float	RO	Read Input (0x04)	2	
		Hygro - PPMv	410	5510	32-bit float	RO	Read Input (0x04)	2	
		Hygro - PPBv	412	5512	32-bit float	RO	Read Input (0x04)	2	
		Hygro - PPMw	414	5514	32-bit float	RO	Read Input (0x04)	2	
		Hygro - RH %	416	5516	32-bit float	RO	Read Input (0x04)	2	
		Hygro - Lbs/MMSCF (ideal gas)	418	5518	32-bit float	RO	Read Input (0x04)	2	
		Hygro - Lbs/MMSCF (natural gas)	420	5520	32-bit float	RO	Read Input (0x04)	2	
		Hygro - PPMv (natural gas)	422	5522	32-bit float	RO	Read Input (0x04)	2	
		Hygro - g/m <sup>3</sup>	424	5524	32-bit float	RO	Read Input (0x04)	2	
		Hygro - mg/m <sup>3</sup>	426	5526	32-bit float	RO	Read Input (0x04)	2	
		Hygro - Vapor Pressure (kPa)	428	5528	32-bit float	RO	Read Input (0x04)	2	
		Hygro - Vapor Pressure (mm Hg)	430	5530	32-bit float	RO	Read Input (0x04)	2	
		Hygro - MH / FH	432	5532	32-bit float	RO	Read Input (0x04)	2	
		Temperature - °C	434	5534	32-bit float	RO	Read Input (0x04)	2	
		Temperature - °F	436	5536	32-bit float	RO	Read Input (0x04)	2	
		Temperature - Kelvin	438	5538	32-bit float	RO	Read Input (0x04)	2	
		Temperature - Rankine	440	5540	32-bit float	RO	Read Input (0x04)	2	
		Pressure - kPa-gauge	442	5542	32-bit float	RO	Read Input (0x04)	2	
		Pressure - Mpa-gauge	444	5544	32-bit float	RO	Read Input (0x04)	2	
		Pressure - Pa-gauge	446	5546	32-bit float	RO	Read Input (0x04)	2	
		Pressure - Bar-gauge	448	5548	32-bit float	RO	Read Input (0x04)	2	
		Pressure - kPa -absolute	450	5550	32-bit float	RO	Read Input (0x04)	2	

**Table 13: Modbus Register Map (cont.)**

Function	Parameter	Sub Parameter	ID	Modbus Address	Type	Access	Modbus Request	Qty. of Registers	Notes
		Pressure - MPa -absolute	452	5552	32-bit float	RO	Read Input (0x04)	2	
		Pressure - Pa -absolute	454	5554	32-bit float	RO	Read Input (0x04)	2	
		Pressure - Bar -absolute	456	5556	32-bit float	RO	Read Input (0x04)	2	
		Pressure - Atm	458	5558	32-bit float	RO	Read Input (0x04)	2	
		Pressure - PSia	460	5560	32-bit float	RO	Read Input (0x04)	2	
		Pressure - PSig	462	5562	32-bit float	RO	Read Input (0x04)	2	
		Pressure - mm Hg	464	5564	32-bit float	RO	Read Input (0x04)	2	
		Pressure - FP	466	5566	32-bit float	RO	Read Input (0x04)	2	
		Oxygen - PPM	470	5570	32-bit float	RO	Read Input (0x04)	2	
		Oxygen - PPB	472	5572	32-bit float	RO	Read Input (0x04)	2	
		Oxygen - Percent	474	5574	32-bit float	RO	Read Input (0x04)	2	
		Oxygen - $\mu$ A	476	5576	32-bit float	RO	Read Input (0x04)	2	
		Aux A	480	5580	32-bit float	RO	Read Input (0x04)	2	
		Aux A scaled	482	5582	32-bit float	RO	Read Input (0x04)	2	
		Aux B	484	5584	32-bit float	RO	Read Input (0x04)	2	
		Aux B scaled	486	5586	32-bit float	RO	Read Input (0x04)	2	
		User Function 1	490	5590	32-bit float	RO	Read Input (0x04)	2	
		User Function 2	492	5592	32-bit float	RO	Read Input (0x04)	2	
		User Function 3	494	5594	32-bit float	RO	Read Input (0x04)	2	
		User Function 4	496	5596	32-bit float	RO	Read Input (0x04)	2	
	Channel 6	Hygro - Dew Point °C	502	5602	32-bit float	RO	Read Input (0x04)	2	
		Hygro - Dew Point °F	504	5604	32-bit float	RO	Read Input (0x04)	2	
		Hygro - Equiv. Dew Point °C	506	5606	32-bit float	RO	Read Input (0x04)	2	
		Hygro - Equiv. Dew Point °F	508	5608	32-bit float	RO	Read Input (0x04)	2	

**Table 13: Modbus Register Map (cont.)**

Function	Parameter	Sub Parameter	ID	Modbus Address	Type	Access	Modbus Request	Qty. of Registers	Notes
		Hygro - PPMv	510	5610	32-bit float	RO	Read Input (0x04)	2	
		Hygro - PPBv	512	5612	32-bit float	RO	Read Input (0x04)	2	
		Hygro - PPMw	514	5614	32-bit float	RO	Read Input (0x04)	2	
		Hygro - RH %	516	5616	32-bit float	RO	Read Input (0x04)	2	
		Hygro - Lbs/MMSCF (ideal gas)	518	5618	32-bit float	RO	Read Input (0x04)	2	
		Hygro - Lbs/MMSCF (natural gas)	520	5620	32-bit float	RO	Read Input (0x04)	2	
		Hygro - PPMv (natural gas)	522	5622	32-bit float	RO	Read Input (0x04)	2	
		Hygro - g/m <sup>3</sup>	524	5624	32-bit float	RO	Read Input (0x04)	2	
		Hygro - mg/m <sup>3</sup>	526	5626	32-bit float	RO	Read Input (0x04)	2	
		Hygro - Vapor Pressure (kPa)	528	5628	32-bit float	RO	Read Input (0x04)	2	
		Hygro - Vapor Pressure (mm Hg)	530	5630	32-bit float	RO	Read Input (0x04)	2	
		Hygro - MH / FH	532	5632	32-bit float	RO	Read Input (0x04)	2	
		Temperature - °C	534	5634	32-bit float	RO	Read Input (0x04)	2	
		Temperature - °F	536	5636	32-bit float	RO	Read Input (0x04)	2	
		Temperature - Kelvin	538	5638	32-bit float	RO	Read Input (0x04)	2	
		Temperature - Rankine	540	5640	32-bit float	RO	Read Input (0x04)	2	
		Pressure - kPa-gauge	542	5642	32-bit float	RO	Read Input (0x04)	2	
		Pressure - Mpa-gauge	544	5644	32-bit float	RO	Read Input (0x04)	2	
		Pressure - Pa-gauge	546	5646	32-bit float	RO	Read Input (0x04)	2	
		Pressure - Bar-gauge	548	5648	32-bit float	RO	Read Input (0x04)	2	
		Pressure - kPa-absolute	550	5650	32-bit float	RO	Read Input (0x04)	2	
		Pressure - MPa-absolute	552	5652	32-bit float	RO	Read Input (0x04)	2	



**Table 13: Modbus Register Map (cont.)**

Function	Parameter	Sub Parameter	ID	Modbus Address	Type	Access	Modbus Request	Qty. of Registers	Notes
		Pressure - Pa -absolute	554	5654	32-bit float	RO	Read Input (0x04)	2	
		Pressure - Bar -absolute	556	5656	32-bit float	RO	Read Input (0x04)	2	
		Pressure - Atm	558	5658	32-bit float	RO	Read Input (0x04)	2	
		Pressure - PSla	560	5660	32-bit float	RO	Read Input (0x04)	2	
		Pressure - PSlg	562	5662	32-bit float	RO	Read Input (0x04)	2	
		Pressure - mm Hg	564	5664	32-bit float	RO	Read Input (0x04)	2	
		Pressure - FP	566	5666	32-bit float	RO	Read Input (0x04)	2	
		Oxygen - PPM	570	5670	32-bit float	RO	Read Input (0x04)	2	
		Oxygen - PPB	572	5672	32-bit float	RO	Read Input (0x04)	2	
		Oxygen - Percent	574	5674	32-bit float	RO	Read Input (0x04)	2	
		Oxygen - $\mu$ A	576	5676	32-bit float	RO	Read Input (0x04)	2	
		Aux A	580	5680	32-bit float	RO	Read Input (0x04)	2	
		Aux A scaled	582	5682	32-bit float	RO	Read Input (0x04)	2	
		Aux B	584	5684	32-bit float	RO	Read Input (0x04)	2	
		Aux B scaled	586	5686	32-bit float	RO	Read Input (0x04)	2	
		User Function 1	590	5690	32-bit float	RO	Read Input (0x04)	2	
		User Function 2	592	5692	32-bit float	RO	Read Input (0x04)	2	
		User Function 3	594	5694	32-bit float	RO	Read Input (0x04)	2	
		User Function 4	596	5696	32-bit float	RO	Read Input (0x04)	2	
10000		System Serial Number	0	10000	16-byte string	RO	Read Input (0x04)	8	
		System Firmware Version	2	10002	16-byte string	RO	Read Input (0x04)	8	
		ModuleStatus	10	10010	32-bit Integer	RO	Read Input (0x04)	2	0 = No modules inst. 1 = Module A inst., 2 = Module B Inst., 3 = Both Modules inst.

**Table 13: Modbus Register Map (cont.)**

Function	Parameter	Sub Parameter	ID	Modbus Address	Type	Access	Modbus Request	Qty. of Registers	Notes
		Mainboard - Temperature, °C	40	10040	32-bit float	RO	Read Input (0x04)	2	
		Module A - Number of Channels	100	10100	32-bit Integer	RO	Read Input (0x04)	2	0 = No modules inst. 1 = Module A inst., 2 = Module B Inst., 3 = Both Modules inst.
		Module A - Serial Number	102	10102	16-byte string	RO	Read Input (0x04)	8	
		Module A - Firmware Version	104	10104	16-byte string	RO	Read Input (0x04)	8	
		Module A - Temperature, °C	140	10140	32-bit float	RO	Read Input (0x04)	2	
		Module B - Number of Channels	200	10200	32-bit Integer	RO	Read Input (0x04)	2	0 = No module, 1 = 1 Chan, 3 = 3 Chan
		Module B - Serial Number	202	10202	16-byte string	RO	Read Input (0x04)	8	
		Module B - Firmware Version	204	10204	16-byte string	RO	Read Input (0x04)	8	
		Module B - Temperature, °C	240	10240	32-bit float	RO	Read Input (0x04)	2	

<b>A</b>	
Adapter, M-Series Probe .....	11
Adapter, TF-Series Probe .....	10
Alarms	
Fault .....	99
Menu Map .....	110
Range Error Response .....	55
Setting Up .....	53
Specifications .....	99, 103
Testing .....	54
Analog Outputs	
see Outputs	
Auto-Cal	
Set Schedule .....	65
Specifications .....	102
<b>B</b>	
Background Gas Correction	
Factors .....	92
Oxygen Cell .....	91
Brightness .....	40
<b>C</b>	
Cable Error .....	21
Cables	
Cable Error .....	21
Installation Restrictions .....	2
Length .....	21
Calibration	
Auto-Cal Schedule .....	65
Delta F Oxygen Cell .....	89
Probes .....	89
Ranges .....	100
Reminder .....	45
Calibration Data Sheet, Probes .....	66
Cancel Button .....	34
Chassis, Updating Firmware .....	117
Check Button .....	34
Common Problems .....	96
Communications	
Ethernet LAN .....	77
Menu Map .....	112
Modbus/RTU .....	76
Serial Port .....	75
Setting Up .....	75
VNC Server .....	82
Configuration	
Menu .....	59
Probes .....	60
Connections	
Electrical .....	14
Oxygen Cell Process Lines .....	13
Constants, User .....	72
<b>D</b>	
Data Element Editor .....	32
Data Logging .....	102
Data Views .....	40
Delta F Oxygen Cell	
Background Gas Correction .....	91
Calibration .....	89
Electrical Connections .....	21
Electrolyte Maintenance .....	87
Establishing a Gas Flow .....	26
Explosion-Proof .....	25
Installing .....	12
Mounting .....	8
Preparing .....	13
Process Connections .....	13
Sample System .....	6
Specifications .....	107
Standard .....	23
Weatherproof .....	24
Digital Outputs .....	103
Dimensions .....	99
Display	
Settings .....	40
Specifications .....	102
Drawings	
Panel Mount Model .....	115
Rack Mount Model .....	114
<b>E</b>	
Electrical Connections .....	14
Delta F Oxygen Cell .....	21
Input Power .....	16
Moisture Image Series Probe .....	19
Moisture Probes .....	16
M-Series Probes .....	17
Press Lock Lever .....	15

Electrolyte		Intrinsic Safety	99
Checking the Level	88		
Oxygen Cell	87	<b>L</b>	
Replenishing	88	Logs	
Electronics Unit		Creating	57
Installation Site, Choosing	2	Menu Map	110
Mounting	7	Setting Up and Running	56
Specifications	99	Specifications	102
Ethernet		Low Voltage Directive	2
Capabilities	78		
Configuring TCP/IP	77	<b>M</b>	
Connecting	77	Main Menu	31
		Maintenance	87
<b>F</b>		Oxygen Cell	87
Fault Alarm		Replacing and Recalibrating Probes	89
Setup	46	Measurements	
Specifications	99	Display	31
File Manager	42	Modes and Units	61
Firmware		Oxygen, Specifications	101
Updating	48	Menu	
Updating Chassis	117	Alarms	53
Updating Module	121	Configuration	59
Functions, User	69	Logger	56
		Outputs	49
<b>G</b>		Service	48
Gas Flow, Establishing for Oxygen Cell	26	Settings	39
		Menu Map	
<b>H</b>		Alarms	110
Help Button	32	Communications	112
		Logger	110
<b>I</b>		Outputs	110
Initial Setup	34	Probe	111
Input Power, Connecting	16	Settings	109
Inputs		User	111
Connecting	14	Modbus	
Specifications	99, 104	Configuring	76
Installation		Register Map	127
Delta F Oxygen Cell	12	Module	
Electrical Connections	14	Setup	47
Electronics Unit	7	Updating Firmware	121
General Guidelines	2	Moisture Image Series Probe	
Moisture Probe Considerations	3	Electrical Connections	19
Probes	9	Specifications	105
Sample System	5, 7	Moisture Measurement Specifications	100
Site Selection	2		
Starting Gas Flow	26		

Moisture Probes		Probes	
Considerations for Installation.....	3	Calibration Data Sheet .....	66
Electrical Connections.....	16	Configuration .....	59, 60
M-Series Adapter.....	11	Installing in Sample System.....	9
TF-Series Adapter .....	10	M-Series Adapter.....	11
Mounting		Recalibrating.....	89
Delta F Oxygen Cell.....	8	Replacing .....	89
Electronics Unit .....	7	Specifications .....	105
Sample System.....	7	TF-Series Adapter .....	10
M-Series Probe Adapter.....	11		
M-Series Probes		<b>R</b>	
Electrical Connections.....	17	Rack Mount Model.....	114
Specifications .....	106	Range Error Response	
<b>N</b>		Alarms .....	55
Notifications Setup .....	45	Outputs.....	52
<b>O</b>		Registration .....	vii
Online Help.....	32	Restarting the System .....	35, 48
Operating Pressure .....	100	<b>S</b>	
Operating Temperature .....	102	Safety	
Outputs		Auxiliary Equipment.....	viii
Configuring.....	49	General Issues .....	vii
Digital .....	103	Personal Equipment.....	viii
Menu Map.....	110	Sample System.....	9
Range Error Response .....	52	Guidelines .....	5
Setting up.....	49	Moisture .....	5
Specifications .....	99, 103	Mounting.....	7
Testing .....	50	Oxygen.....	6
Trimming.....	51	Screen Messages .....	93
Updating.....	103	Sensors	
Oxygen Cell		Module Setup .....	47
see Delta F Oxygen Cell		Pressure .....	12
<b>P</b>		Serial Port, Configuring .....	75
Panel Mount Model .....	115	Service Menu .....	48
Powering Up.....	31	Services .....	vii
Pressure		Settings	
Measurement Specifications.....	101	Display.....	40
Operating .....	100	Menu .....	39
Rating.....	101	Menu Map.....	109
Sensors .....	12	System.....	41
Probe Menu Map.....	111	Shutting Down the System.....	36, 48
		Site Selection.....	2
		Software, Updating.....	48

## Specifications

Alarms .....	99, 103
Auto-Cal .....	102
Delta F Oxygen Cell.....	107
Display .....	102
Electronics .....	99
Fault Alarm.....	99
General .....	102
Inputs .....	99, 104
Logs.....	102
Moisture Measurements.....	100
M-Series Probes.....	106
Outputs .....	99, 103
Oxygen Measurement .....	101
Pressure Measurement .....	101
Probes .....	105
Temperature Measurement.....	100
Storage Temperature .....	102
System	
Dimensions and Weight .....	99
Settings.....	41

**T**

Tables, User.....	71
TCP/IP Connection, Configuring .....	77
Temperature Measurement Specifications .....	100
Terms and Conditions.....	vii
Testing	
Alarms .....	54
Outputs.....	50
TF-Series Probe Adapter .....	10
Trimming an Output .....	51
Troubleshooting .....	93
Common Problems .....	96
Screen Messages.....	93
Typographical Conventions .....	vii

**U**

## User Constants

Entering.....	72
User Functions, Entering .....	69
User Management .....	84
User Menu Map.....	111
User Tables, Entering.....	71

**V**

VNC Server, Configuring .....	82
-------------------------------	----

**W**

Warm-up Time .....	102
Warranty.....	vii
Weight .....	99

## Certification & Safety Statements for the moisture.IQ Moisture and Oxygen Analyzer

### Special Conditions for Safe Use

XP conditions of use for ATEX/IECEx and Zones:

- The flameproof joints of the equipment are not intended to be repaired. Consult the manufacturer if repair of the flameproof joints is necessary.
- Consult the manufacturer for genuine replacement enclosure cover fasteners.

### Installation

When installing this apparatus, the following requirements must be met:

- The temperature rating of the field wiring must be 70°C or greater.
- XP version unused entries should be closed with suitably certified blanking elements.
- The installation should comply with controlled drawing 752-364 (see *Figure 1 on page 2*) and drawing 752-513 Sheets 1-7 (see *Figure 2 on page 2 through Figure 8 on page 5*).
- The installation should comply with configuration drawing 712-1889 Sheets 1-3 (see *Figure 9 on page 6 through Figure 11 on page 7*).
- The installation should comply with installation drawings 712-2126 stainless steel weather-proof (see *Figure 12 on page 7*), 712-2127 explosion-proof (see *Figure 13 on page 8*), and 712-2130 fiberglass weather-proof (see *Figure 14 on page 8*).
- The product cannot be repaired by the user. It must be replaced by an equivalent certified product. Repairs should only be carried out by the manufacturer or by an approved repairer.
- Only trained, competent personnel may install, operate and maintain the equipment.
- If you have questions about whether the apparatus can be used safely in the intended area under the expected operating conditions, please call a BHGE applications engineer.
- See the back cover of the *User's Manual* for contact information.



Installation (cont.)

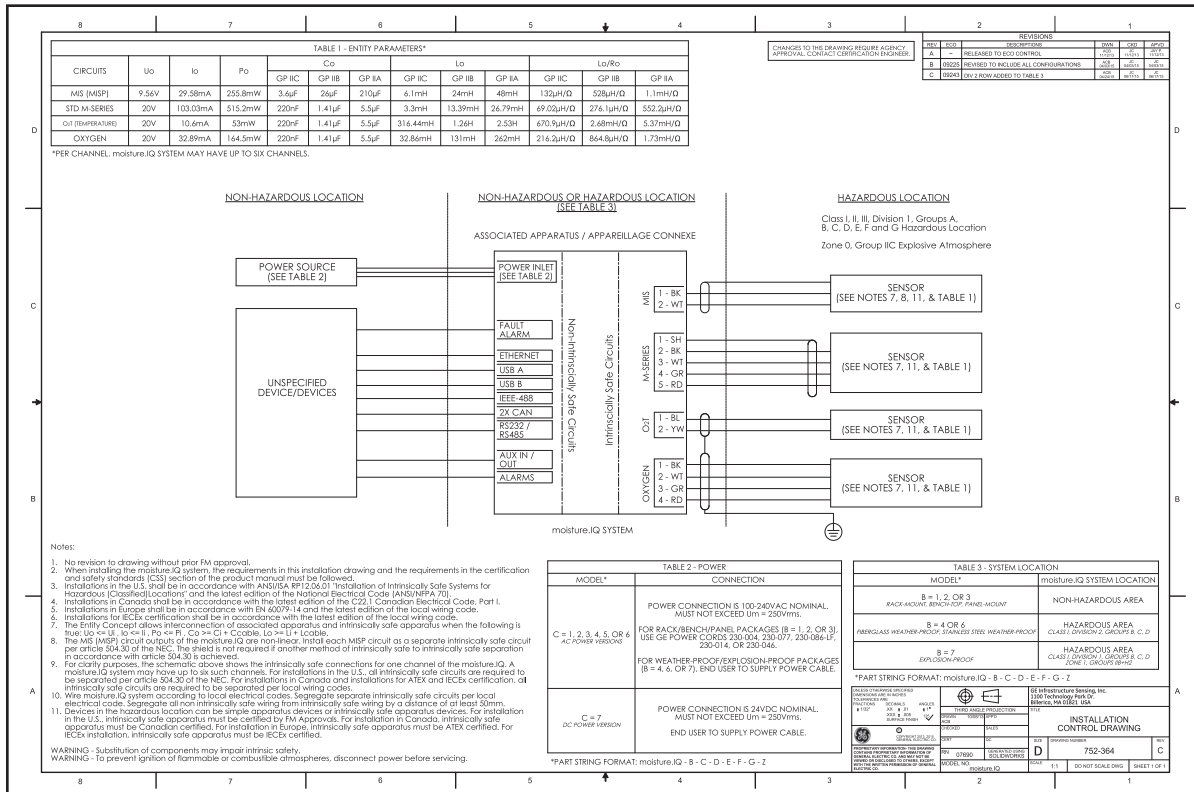

Figure 1: Installation Control Drawing (ref. dwg. 752-364\_C, SH 1 of 1)

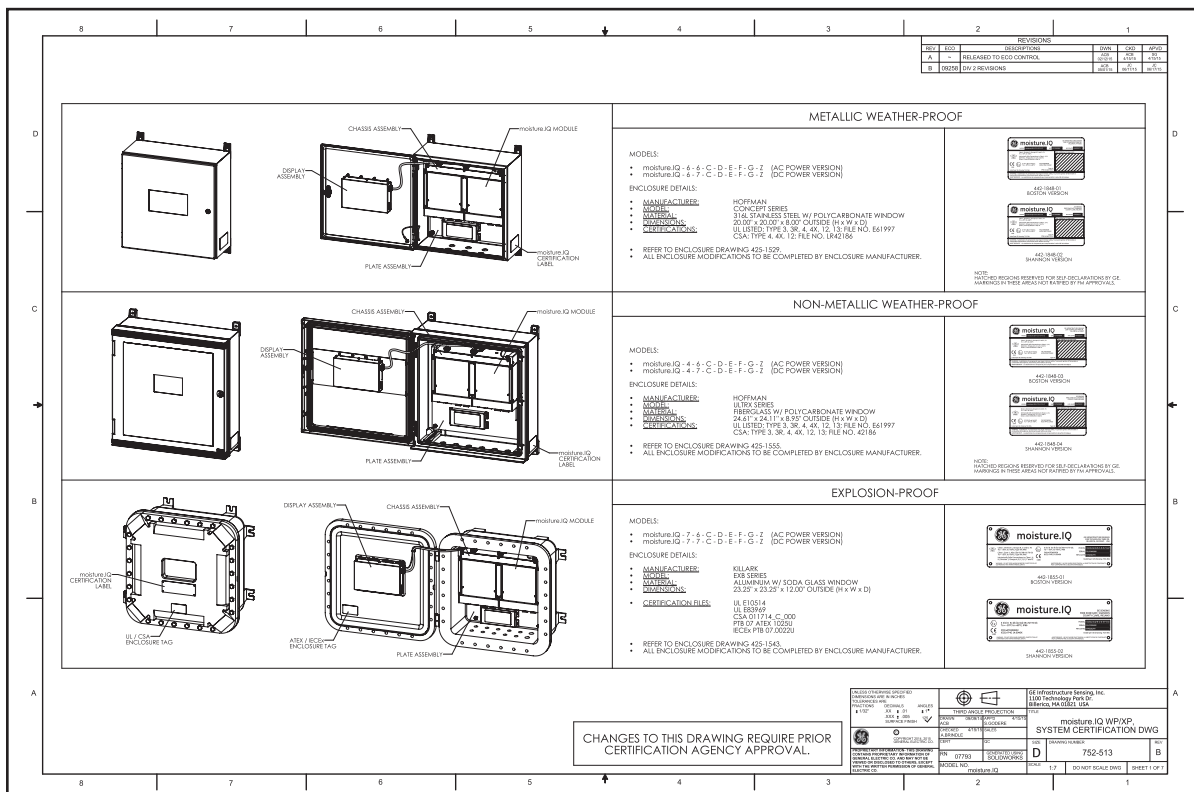

Figure 2: WP/XP System Certification Drawing (ref. dwg. 752-513\_B, SH 1 of 7)



Installation (cont.)

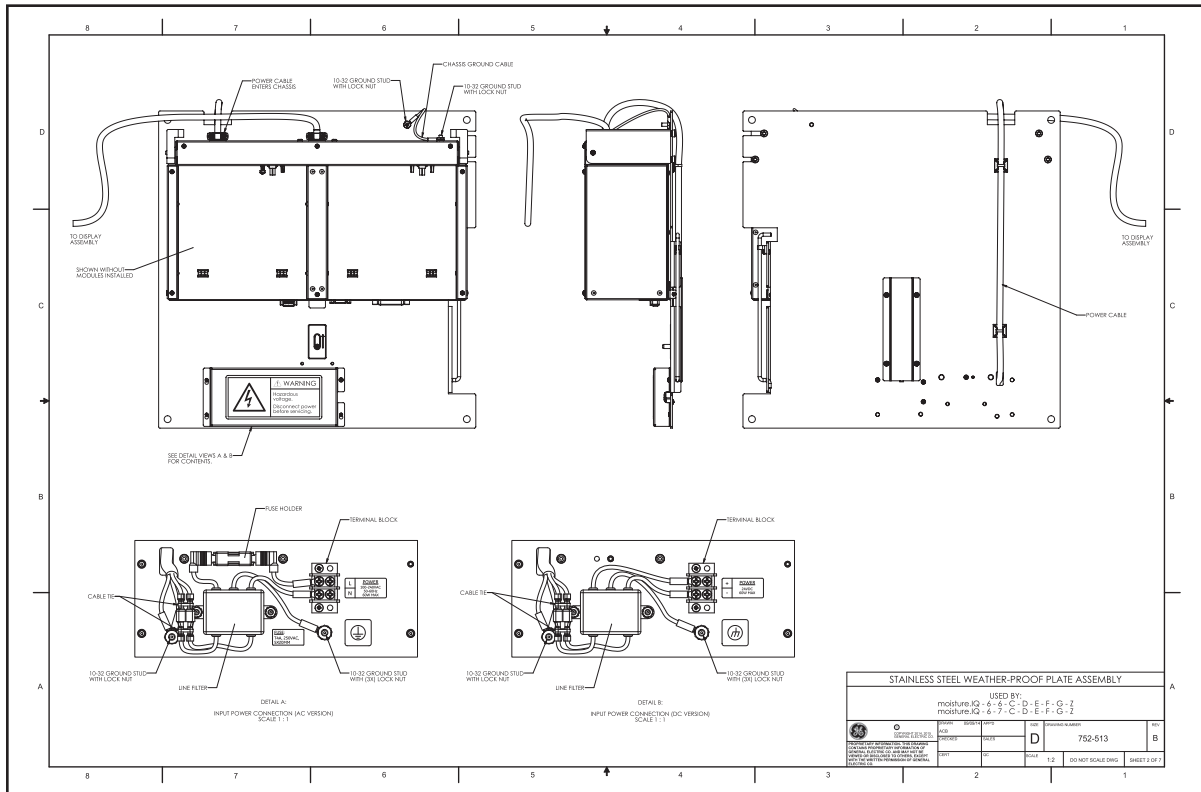

Figure 3: Stainless Steel Weather-Proof Plate Assembly (ref. dwg. 752-513\_B, SH 2 of 7)

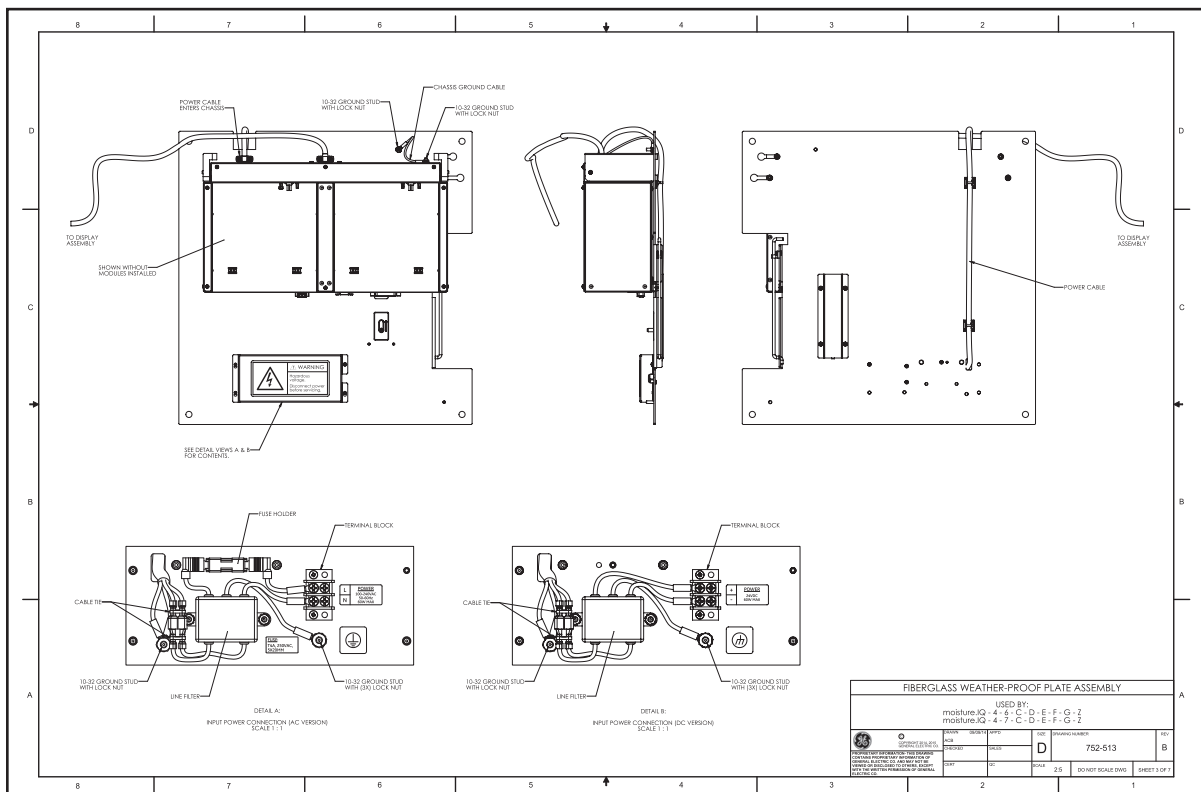

Figure 4: Fiberglass Weather-Proof Plate Assembly (ref. dwg. 752-513\_B, SH 3 of 7)

Installation (cont.)

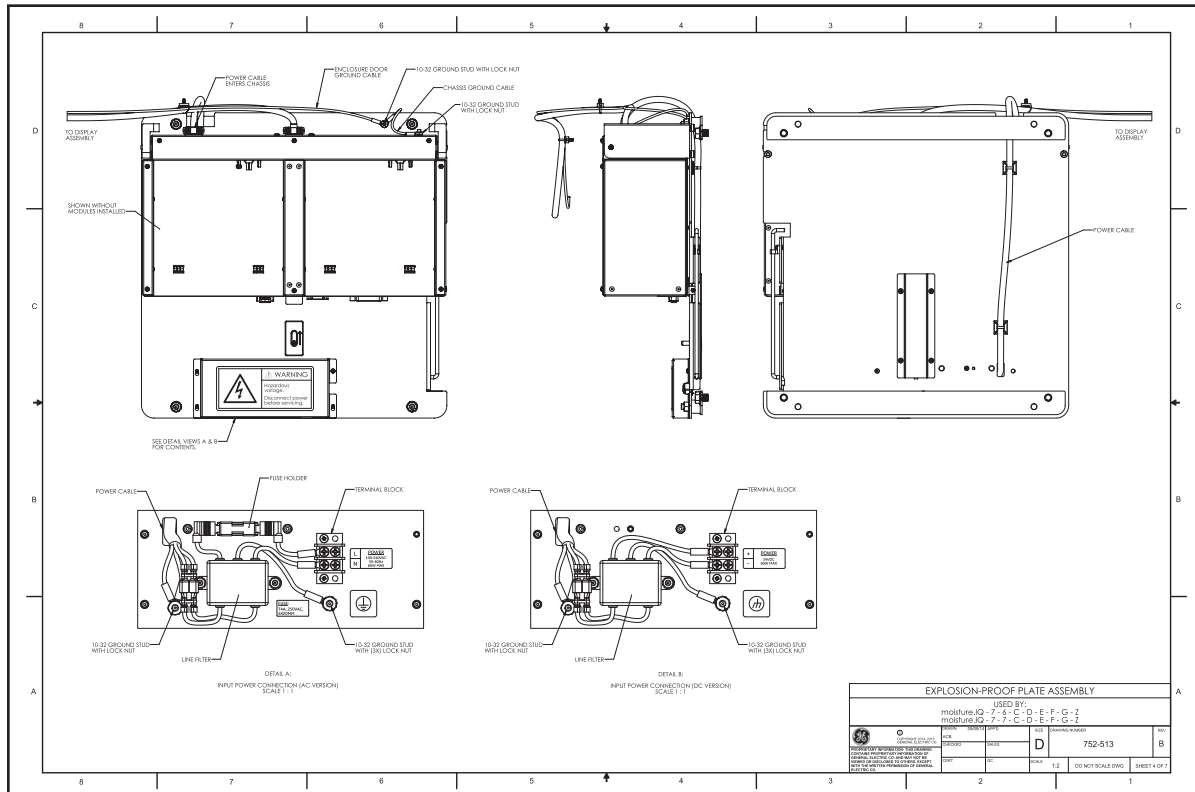

Figure 5: Explosion-Proof Plate Assembly (ref. dwg. 752-513\_B, SH 4 of 7)

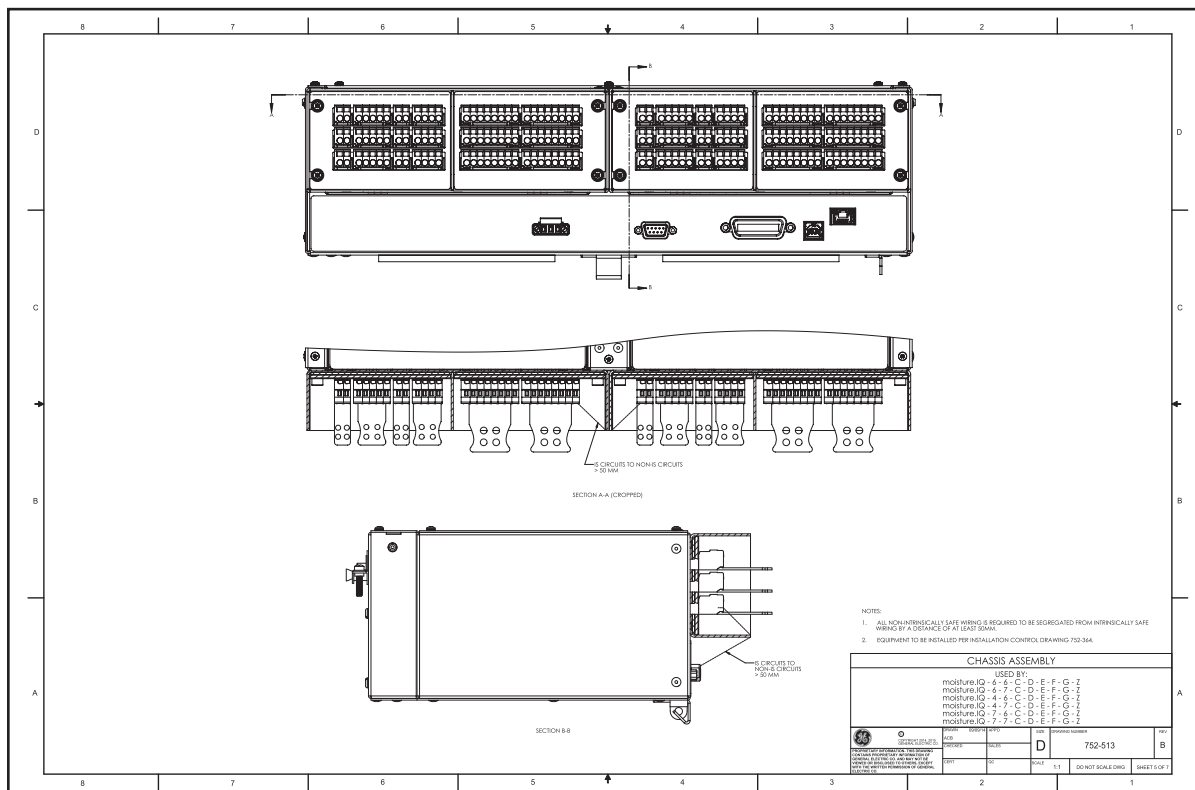

Figure 6: Chassis Assembly-Part 1 (ref. dwg. 752-513\_B, SH 5 of 7)

Installation (cont.)

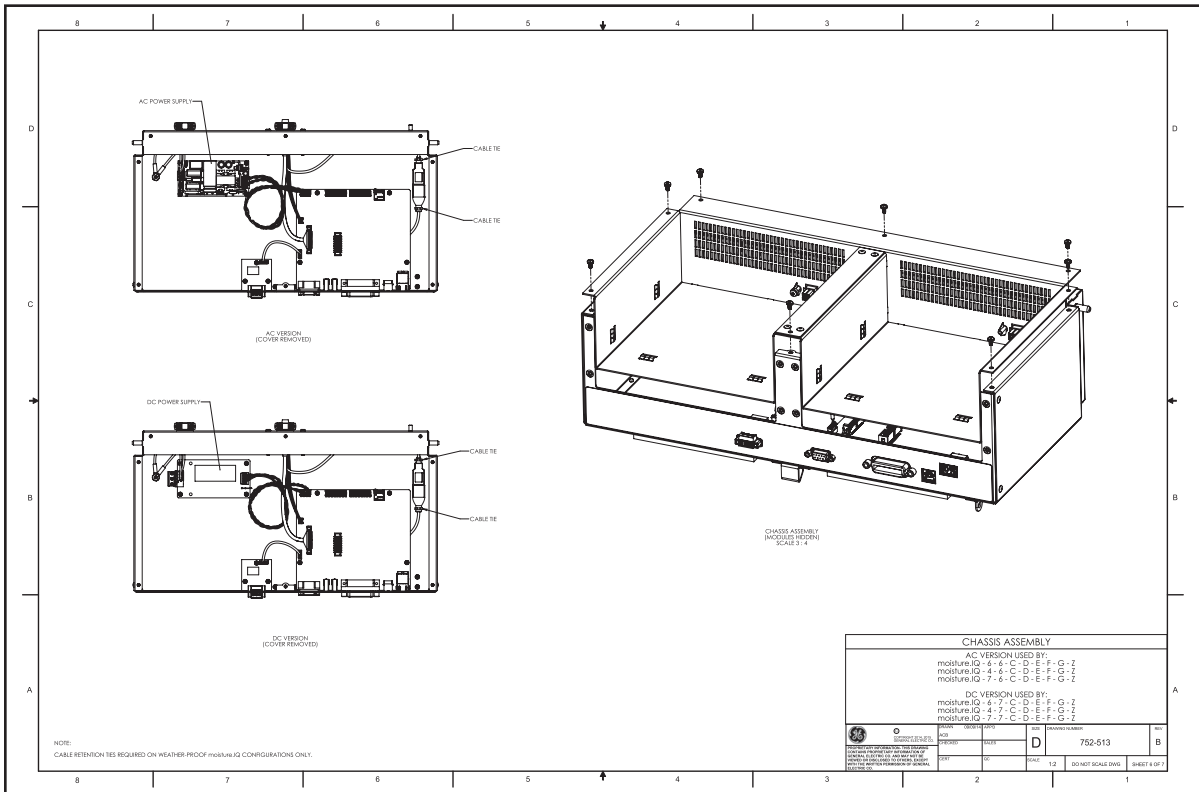

Figure 7: Chassis Assembly-Part 2 (ref. dwg. 752-513\_B, SH 6 of 7)

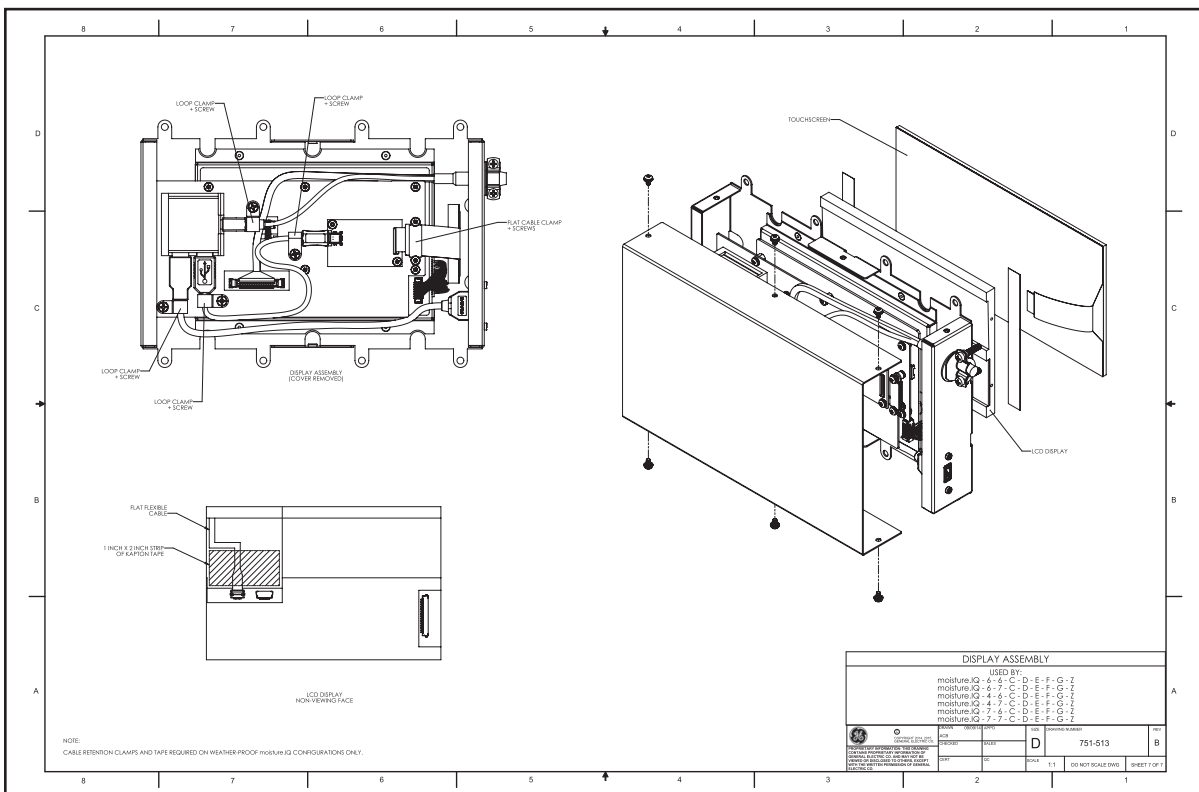

Figure 8: Display Assembly (ref. dwg. 752-513\_B, SH 7 of 7)

Installation (cont.)

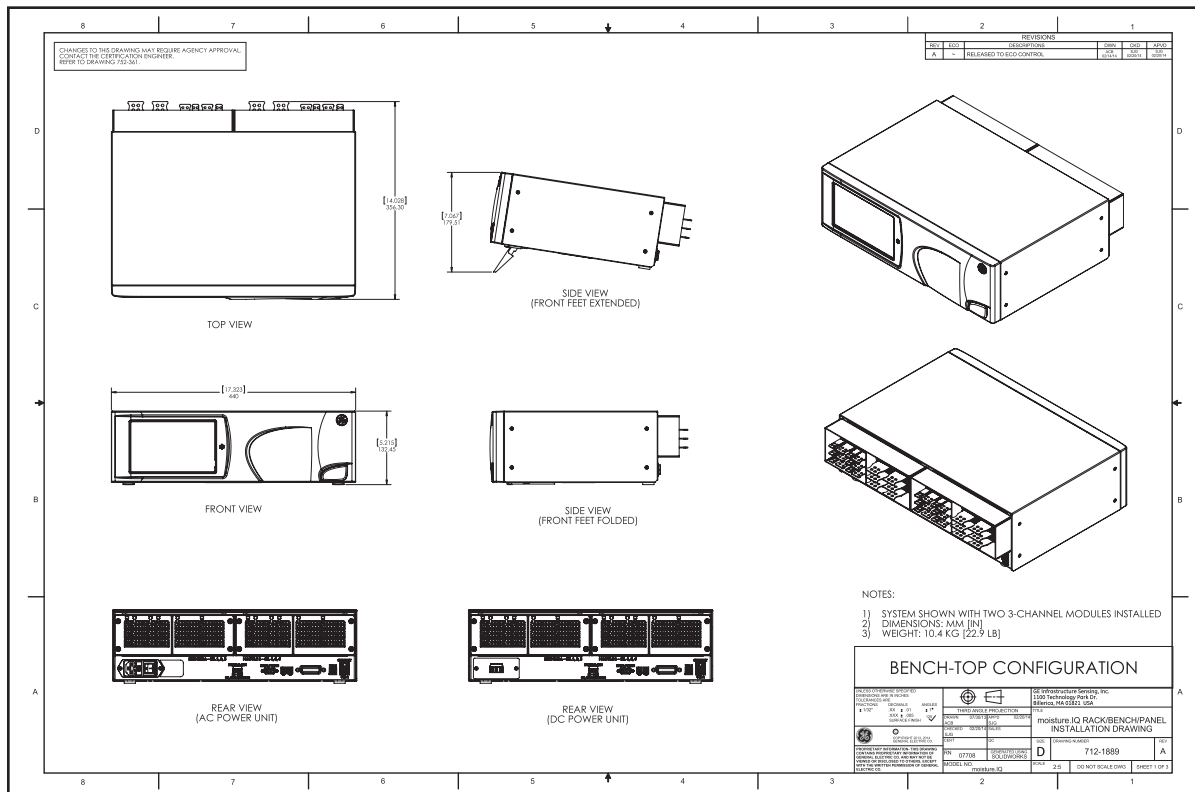

Figure 9: Bench-Top Configuration (Dwg. 712-1889\_revA, SH 1 of 3)

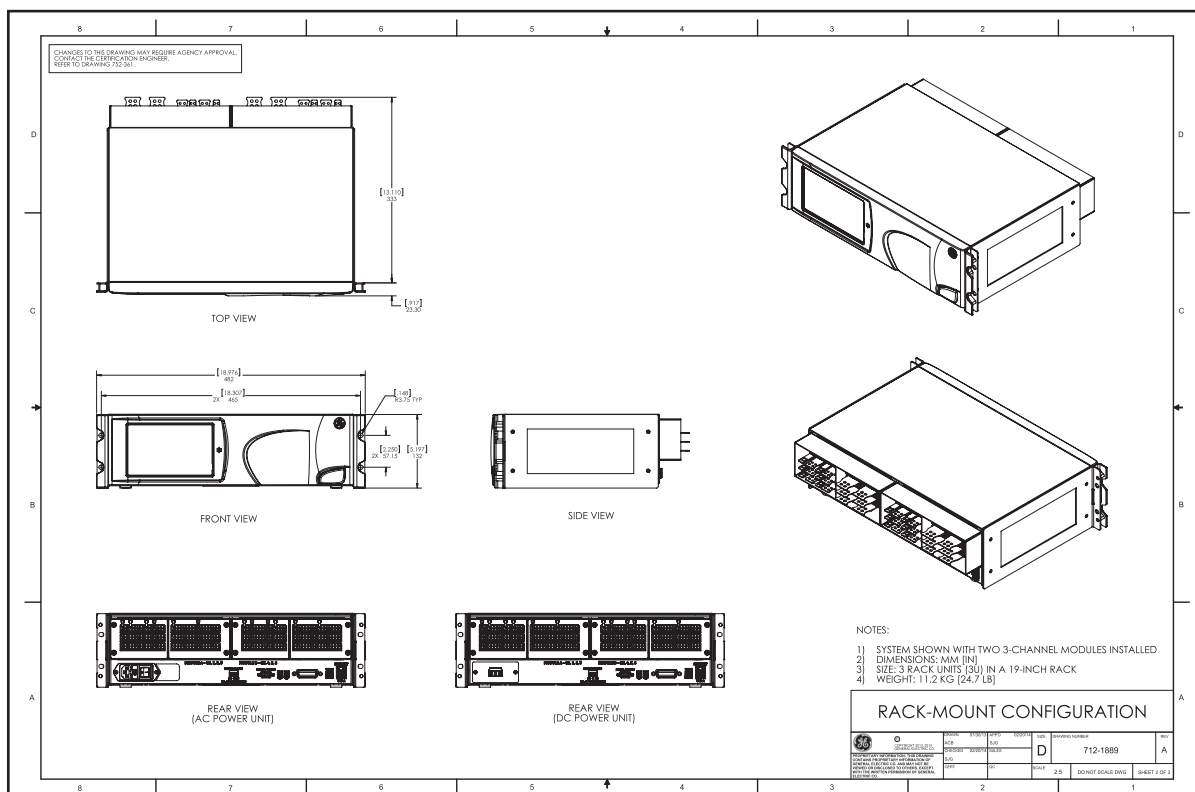

Figure 10: Rack-Mount Configuration (Dwg. 712-1889\_revA, SH 2 of 3)

Installation (cont.)

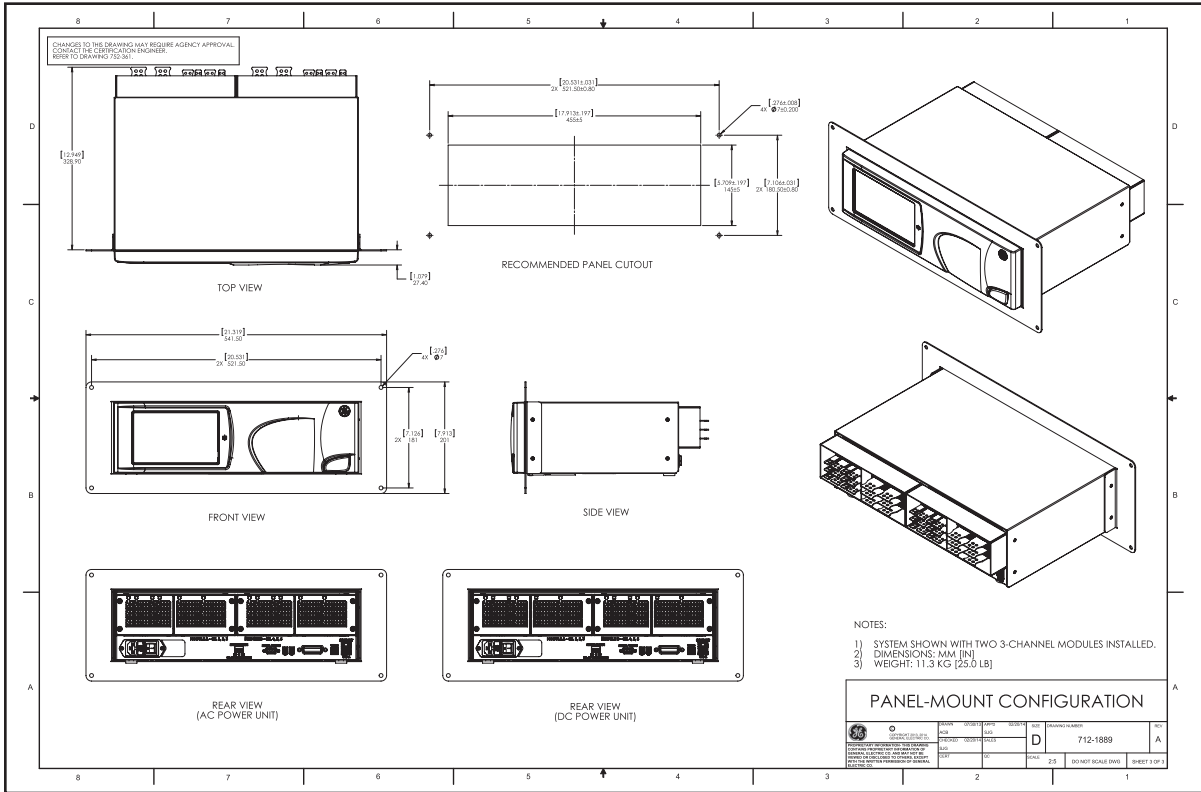

Figure 11: Panel-Mount Configuration (Dwg. 712-1889\_revA, SH 3 of 3)

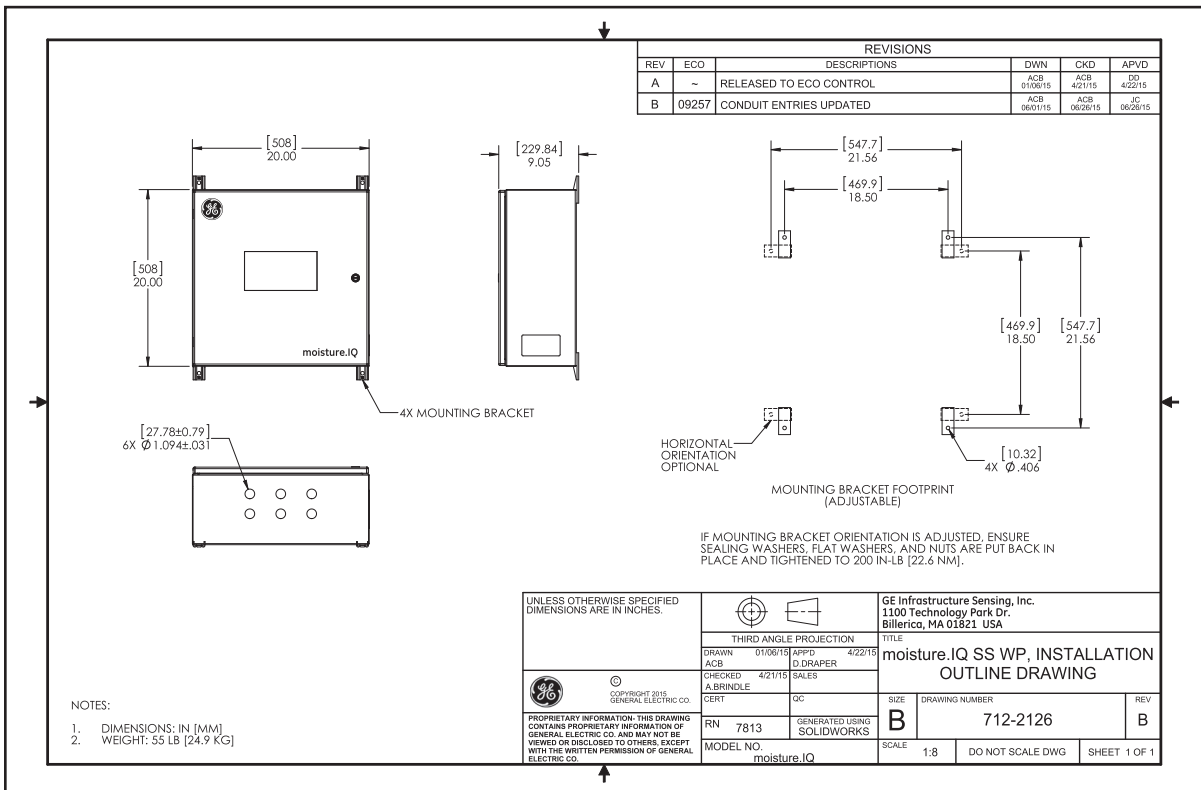

Figure 12: SS-WP Installation Outline Drawing (Dwg. 712-2126\_revB, SH 1 of 1)

Installation (cont.)

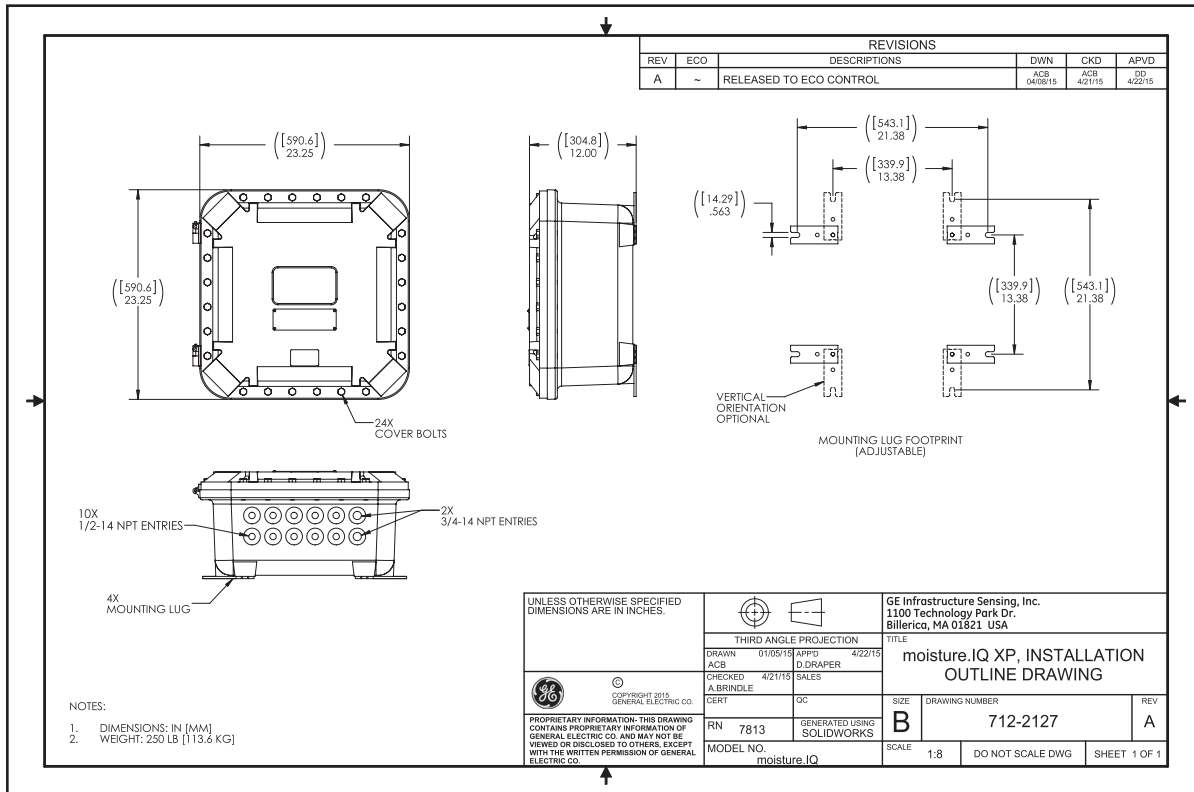

Figure 13: XP Installation Outline Drawing (Dwg. 712-2127\_revA, SH 1 of 1)

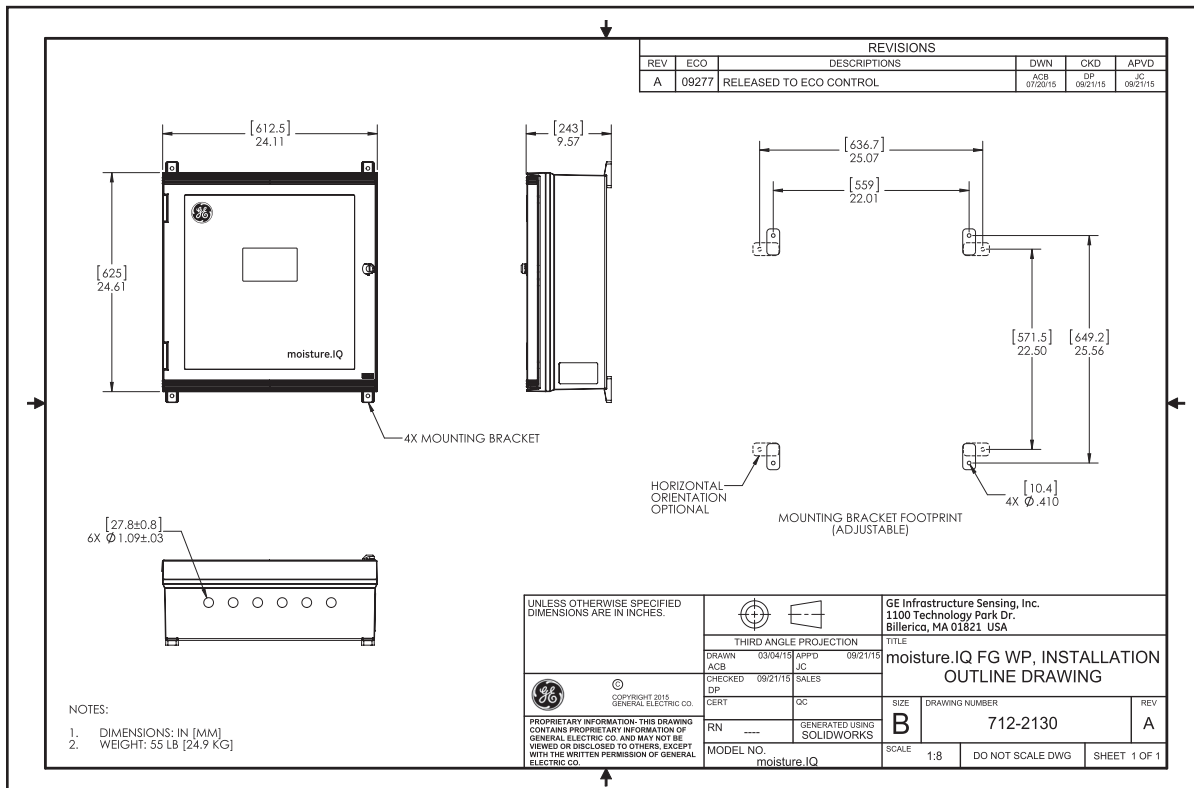
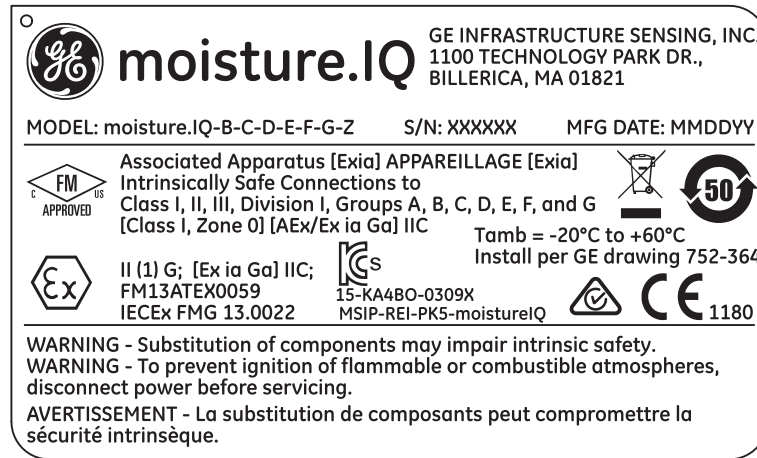

Figure 14: FG-WP Installation Outline Drawing (Dwg. 712-2130\_revA, SH 1 of 1)

**Markings**

- Markings shall appear on the product as shown in *Figure 15* below through *Figure 22* on page 11.



**Figure 15: Product Chassis Label - Boston (ref. dwg. 442-1492-01\_D)**

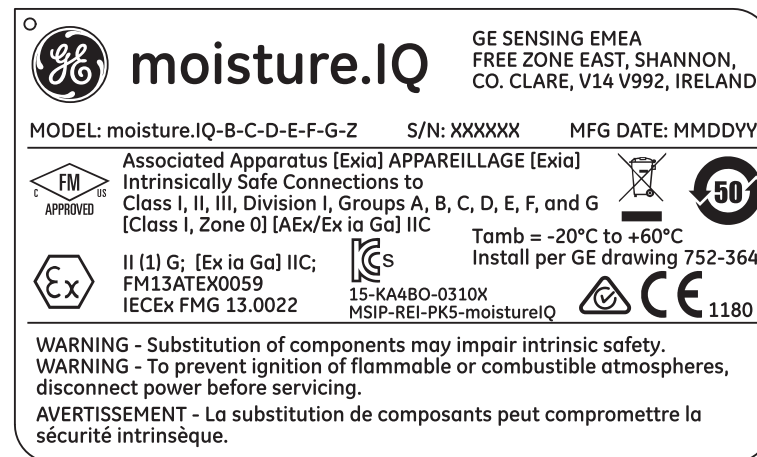

**Figure 16: Product Chassis Label - Shannon (ref. dwg. 442-1492-02\_D)**

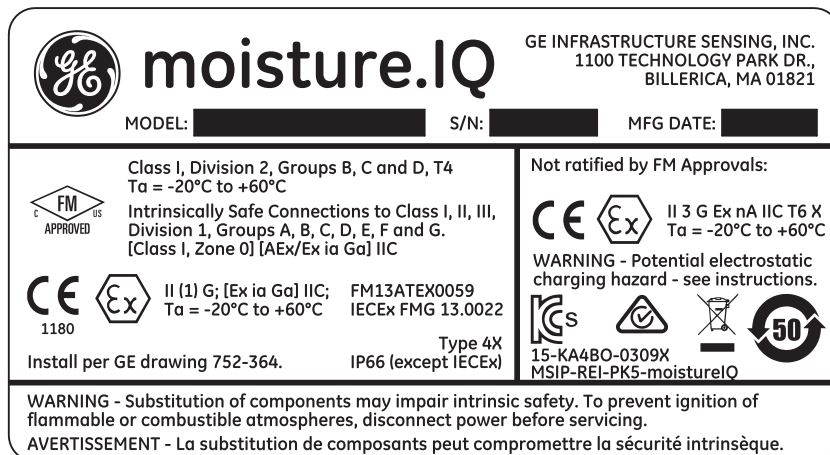

**Figure 17: Stainless Steel, Weather-Proof Certification Label - Boston (ref. dwg. 442-1848-01\_F)**

Markings (cont.)

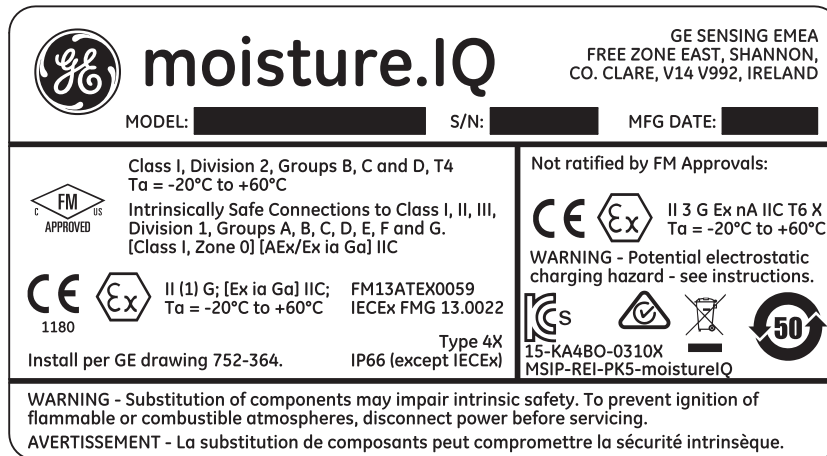

Figure 18: Stainless Steel, Weather-Proof Certification Label - Shannon (ref. dwg. 442-1848-02\_F)

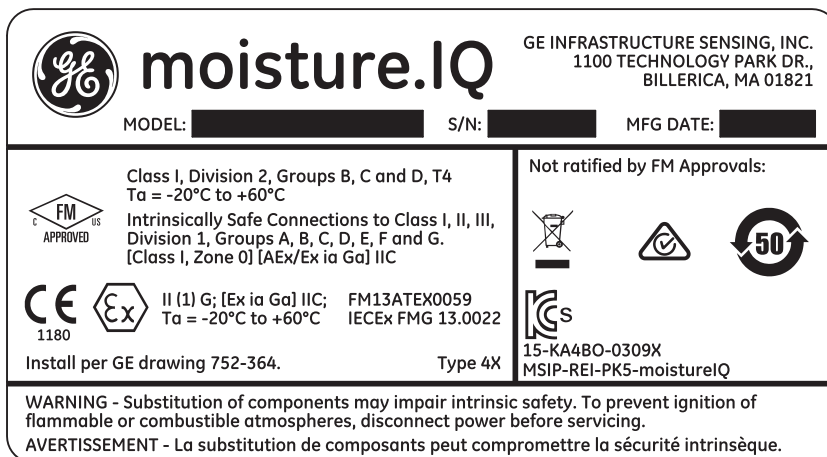

Figure 19: Fiberglass, Weather-Proof Certification Label - Boston (ref. dwg. 442-1848-03\_F)

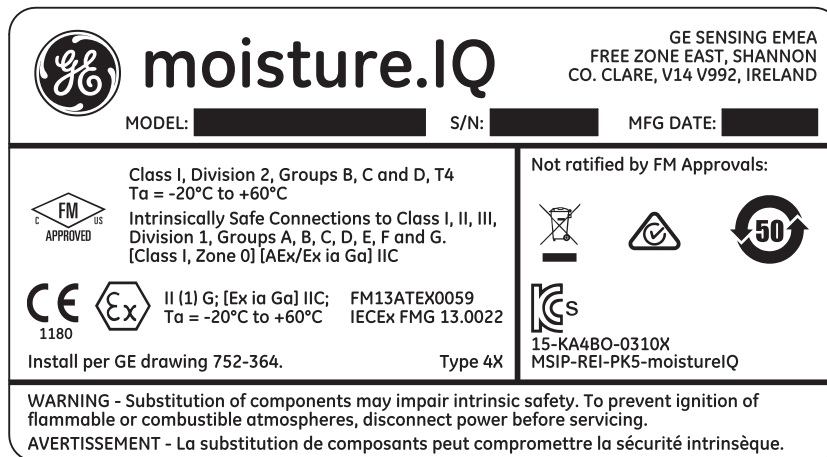

Figure 20: Fiberglass, Weather-Proof Certification Label - Shannon (ref. dwg. 442-1848-04\_F)



Markings (cont.)

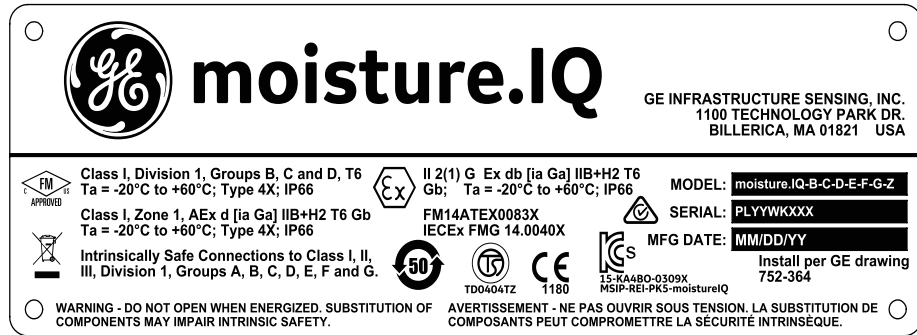

Figure 21: Explosion-Proof Certification Label -Boston (ref. dwg. 442-1855-01\_F)

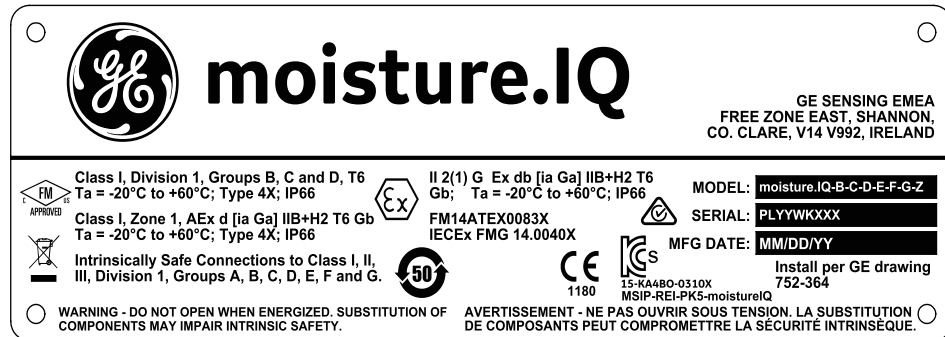

Figure 22: Explosion-Proof Certification Label -Shannon (ref. dwg. 442-1855-02\_F)

[no content intended for this page]

We,

**GE Sensing**  
**1100 Technology Park Drive**  
**Billerica, MA 01821**  
**USA**

declare under our sole responsibility that the

**moisture.IQ Multi-Channel, Multi-Functional Moisture Analyzer**

to which this declaration relates, is in conformity with the following standards:

- EN 60079-0 : 2012
- EN 60079-11 : 2012
- II (1) G [Ex ia Ga] IIC Tamb = -20°C to +60°C 5 - FM13ATEX0059  
(FM Approvals Ltd, Windsor, Berkshire, UK - NoBo 1725)
- EN 61326-1: 2013
- EN 61326-2-3: 2013
- EN 61010-1: 2010

following the provisions of Directives 2004/108/EC EMC, 2006/95/EC LVD and 94/9/EC ATEX.

Billerica - September 1, 2015

Issued



Mr. Gary Kozinski  
Certification & Standards, Lead Engineer



[no content intended for this page]





## Customer Support Centers

### U.S.A.

The Boston Center  
1100 Technology Park Drive  
Billerica, MA 01821  
U.S.A.  
Tel: 800 833 9438 (toll-free)  
978 437 1000  
E-mail: [mstechsupport@bhge.com](mailto:mstechsupport@bhge.com)

### Ireland

Sensing House  
Shannon Free Zone East  
Shannon, County Clare  
Ireland  
Tel: +353 61 61470200  
E-mail: [mstechsupport@bhge.com](mailto:mstechsupport@bhge.com)

[bhge.com](http://bhge.com)

© 2017 Baker Hughes, a GE company – All rights reserved.

Baker Hughes reserves the right to make changes in specifications and features shown herein, or discontinue the product described at any time without notice or obligation. Contact your BHGE representative for the most current information. The Baker Hughes logo is a trade mark of Baker Hughes, a GE company. The GE Monogram is a trademark of the General Electric Company.

910-298 Rev. E